



CABLE PRODUCTS



The top choice of racers and enthusiasts for value and high-performance.

For over 100 years, Taylor Cable Products have represented quality and customer satisfaction in the automotive and performance racing markets.

We are proud to have our Ignition Wire Sets firing some of the fastest race and street vehicles in the world. 8mm Spiro Pro, 8.2mm ThunderVolt, 8mm High Energy, 8mm StreeThunder, and 10.4mm 409 Series Ignition Wire Sets are a testimony to our commitment to innovation and development of highly functional ignition products.

What is the difference between Universal, Race Fit, and Custom Wire Sets?

Universal Wires Sets

- Extra-long wire sets with only one spark plug terminal and boots attached per lead.
- End user cuts each wire to length and attaches distributor/coil terminal and boot.
- All sets come with both HEI and Socket Style boots and terminals in the kit.
- Other types of distributor/coil boot and terminal kits are available.

Race Fit

- Each wire is cut to the exact length, ready to install, with boots and terminals on each end.
- Lengths may not be correct if using fixed looms or running wires in an alternate path.
- Extra-long coil wire is included, one end complete, the other end ready to cut and install the correct boot and terminal on your choice of high-performance coil.

Custom

- Custom Wires are designed to replicate your OE wire set. Each wire is cut to length and booted to match OE wires. Lower resistance will get more fire to your spark plugs, increased horsepower and torque, and improved fuel mileage.

How to shop Custom Ignition Wire Sets

- Choose the Ignition Wire Series that is best suited to your needs:
 - 8mm Spiro Pro
 - 10.4mm Pro Race
 - 8.2mm ThunderVolt
 - 8mm StreeThunder
 - 8mm High Energy Ignition
 - 8mm Pro Wire – Resistor Core and TCW

4 **PERTRONIX PERFORMANCE BRANDS EMISSIONS CODES**
This Product is considered a Replacement Part per CARB and EPA regulations for emissions compliance and is legal for sale and use on specified vehicles in all 50 states as stated in Manufacturer's Application Guide and Installation Instructions. REV 5/2022

6 **PERTRONIX PERFORMANCE BRANDS EMISSIONS CODES**
This Product is Certified by the Manufacturer as being a Non-Emissions Related part per CARB and EPA regulations and therefore does not require emissions certification or CARB EO and is legal in all 50 states. REV 5/2022



8MM SPIRO PRO HIGH PERFORMANCE™ IGNITION WIRE SET

For Street & Strip, Off Road, Street Rod, and Custom Cars.

8mm Spiro Pro wires are engineered to deliver superior performance with unsurpassed quality.

They are the top choice amongst racers and enthusiasts alike with heat protection up to 600° F and 65,000 volts of dielectric strength.

- 8.0 mm Outer Silicone Jacket
 - Rated up to 65K Volts
 - Heat resistant to 600 Degrees
- Silicone inner core provides added heat protection and superior flexibility throughout its lifetime
- 350 ohms per foot
- Highly conductive stainless steel spiral wound core
- Superior RFI / EMI suppression for applications with CD or electronic ignitions, on board computers, stereos or pit radios
- Taylor low profile Silicone Pro Boots
- Double spring lock spark plug terminals
- Universal Fit sets and will require cutting to fit, terminating, and booting the distributor end
- Available in universal applications

Limited Edition 100 Years Script

Introducing our exclusive line of limited edition wires featuring the Taylor 100 Year anniversary script in exciting new color combinations. Don't miss out on this electrifying celebration of a century of excellence!

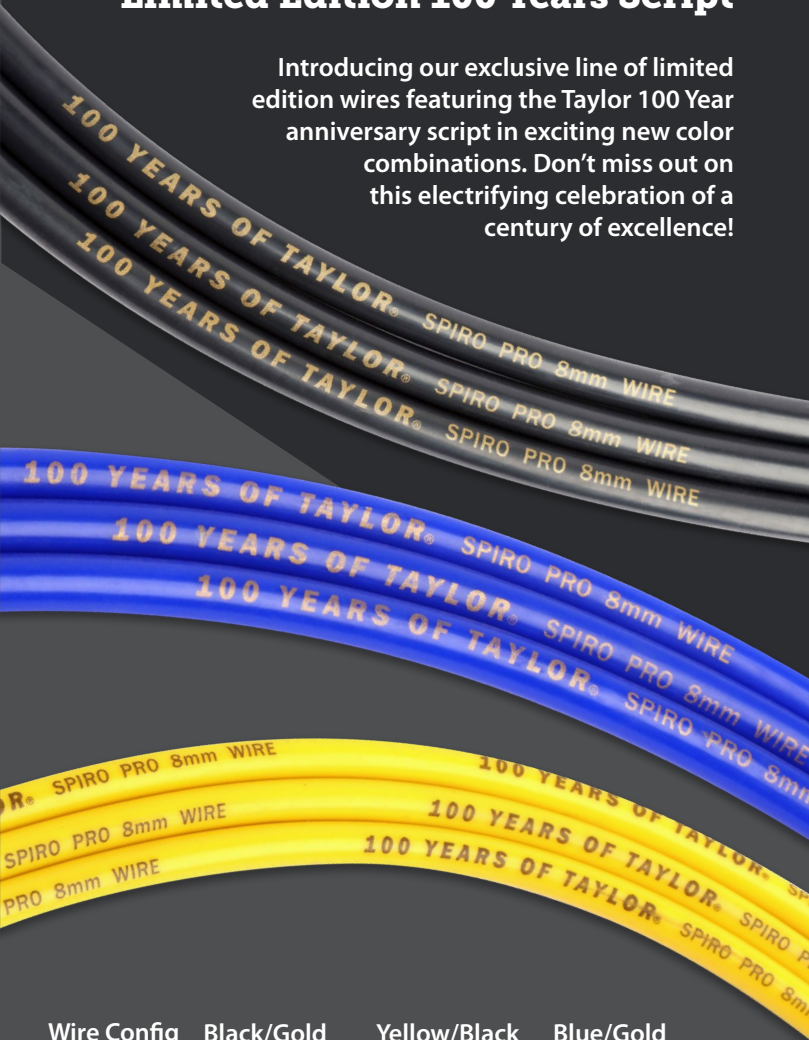

Wire Config	Black/Gold	Yellow/Black	Blue/Gold
90° Boots	-	73451-YR100	73651-YR100
135° Boots	73053-YR100	73453-YR100	73653-YR100
180° Boots	73055-YR100	73455-YR100	73655-YR100



Our Legendary Colors Are Back!

We're bringing back our legendary colored wires, now available in a vibrant array of Pink, Yellow, Orange, Green, Purple, and Gray/Black.

Wire Config	Pink	Yellow	Orange	Green	Purple	Gray/Blk
90° Boots	78751	73451	78351	78551	73151	53851
135° Boots	78753	73453	78353	78553	73153	53853
180° Boots	78755	73455	78355	78555	73155	53855

Celebrate our 100th anniversary in style with Taylor Cable Products.

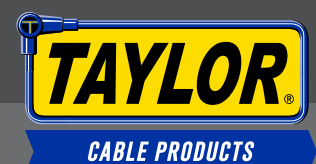

8 SPIRO PRO HIGH PERFORMANCE™ IGNITION WIRE SET

For Street & Strip, Off Road, Street Rod, and Custom Cars.

8mm Spiro Pro wires are engineered to deliver superior performance with unsurpassed quality.

They are the top choice amongst racers and enthusiasts alike with heat protection up to 600° F and 65,000 volts of dielectric strength.

- 8.0 mm Outer Silicone Jacket
 - Rated up to 65K Volts
 - Heat resistant to 600 Degrees
- Silicone inner core provides added heat protection and superior flexibility throughout its lifetime
- 350 ohms per foot
- Highly conductive stainless steel spiral wound core
- Superior RFI / EMI suppression for applications with CD or electronic ignitions, on board computers, stereos or pit radios
- Taylor low profile Silicone Pro Boots
- Double spring lock spark plug terminals
- Available in Black, Red, Blue, Yellow, Purple, Orange, Lime, Gray, and Pink
- Universal Fit sets and will require cutting to fit, terminating, and booting the distributor end
- Available in Universal, Race Fit and Custom apps

Use the Custom Fitment Chart on [pages 22-29](#) to find your fitment

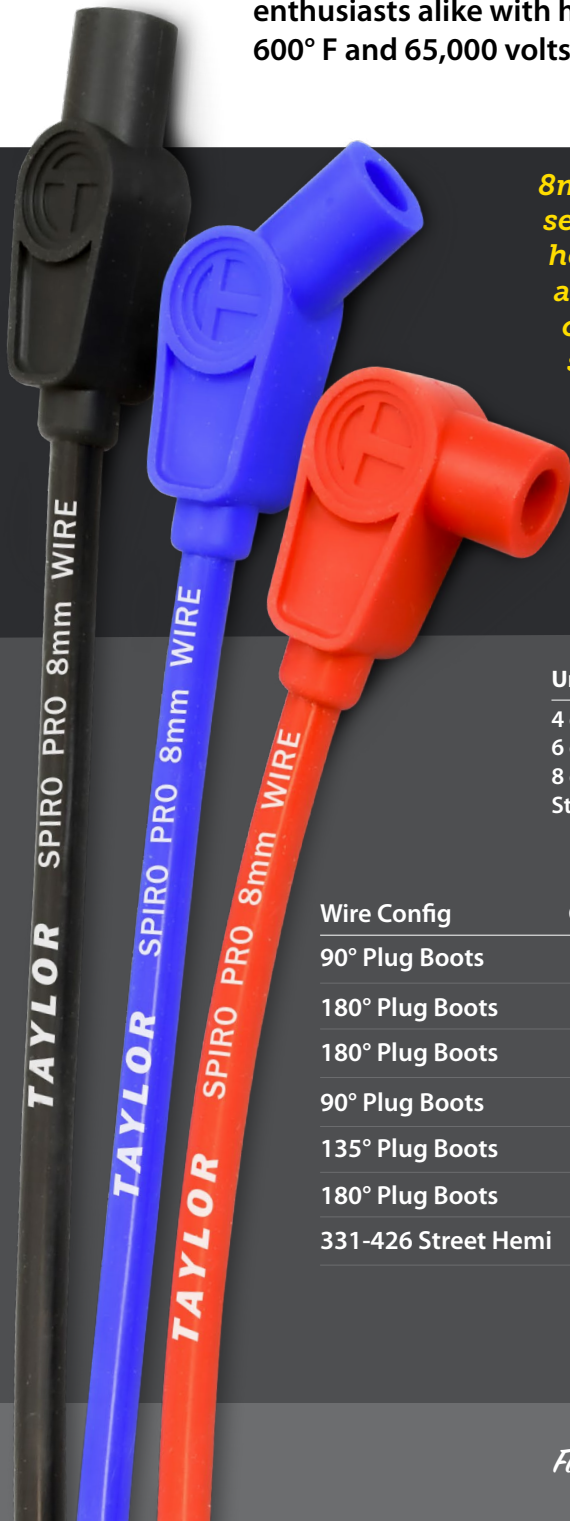

8mm Spiro Pro wire sets offer superior heat protection across a broad range of applications for street and track.

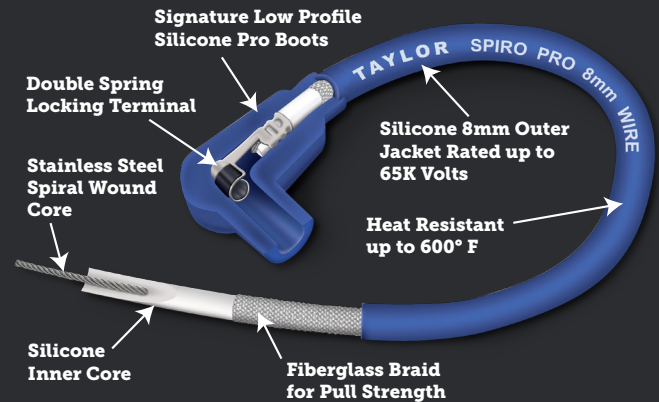

Universal Wire Set Lengths

- 4 cyl - 48, 36, 36, 36, coil 30
- 6 cyl - 46, 44, 42, 30, 28, 28, coil 36
- 8 cyl - 53, 53, 49, 49, 38, 38, 33, 33, coil 36
- Street Hemi - 61, 56, 5, 47, 35, 30, 29, 29, coil 36

Race Fit Part Numbers
TAP HERE (Page 9) →

Wire Config	Cyl	Black	Red	Blue	Yellow	Purple	Orange	Lime	Gray	Pink
90° Plug Boots	4	-	73237	73637	-	-	-	-	-	-
180° Plug Boots	4	73035	73235	73635	-	-	-	-	-	-
180° Plug Boots	6	73045	73245	-	-	-	-	-	-	-
90° Plug Boots	8	73051	73251	73651	73451	73151	78351	78551	53851	78751
135° Plug Boots	8	73053	73253	73653	73453	73153	78353	78553	53853	78753
180° Plug Boots	8	73055	73255	73655	73455	73155	78355	78555	53855	78755
331-426 Street Hemi	8	75089	75289	75689	-	-	-	-	-	-

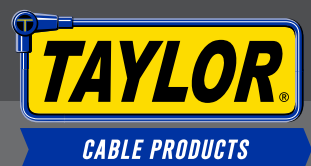

Firing America's Finest Rides Since 1923!



LS UNIVERSAL IGNITION WIRES

- Perfect for coil relocation and custom header applications
- 36" Wires and multiple spark plug boot choices allow the perfect fit
- Spark Plug end is assembled
- Universal Fit sets and will require cutting to fit, terminating, and booting the distributor end



Wire Type	Wire Config	Black	Red	Black Ceramic Wire	Black Red Wire
8mm Spiro Pro	90° Boots	73061	-	75061-B	75261-B
8mm Spiro Pro	135° Boots	73063	-	75063-B	75263-B
8mm Spiro Pro	180° Boots	73065	-	75065-B	75265-B
409 Pro Race	135° Boots	79052	79252	-	-
8.2mm ThunderVolt	90° Boots	83061	-	85061-B	85261-B
8.2mm ThunderVolt	135° Boots	-	-	85063-B	85263-B
8.2mm ThunderVolt	180° Boots	83065	-	85065-B	85265-B

UNIVERSAL CERAMIC WIRES

- 8.0mm and 8.2mm Ceramic Boots
- Provide superior heat protection up to 2000 degrees
- Highly conductive stainless steel spiral wound core
- Superior RFI / EMI suppression for applications with CD or electronic ignitions, on board computers, stereos, or pit radios
- Universal fit sets will require cutting to fit, terminating, and booting the distributor end
- For RVs, Tow Vehicles and High Heat Applications



Universal Wire Set Lengths

8 cyl - 53, 53, 49, 49, 38, 38, 33, 33, coil 36

Wire Type	Wire Config	White Ceramic Wire	White Ceramic Red Wire	White Ceramic Blue Wire	Black Ceramic Wire	Black Ceramic Red Wire
8mm Spiro Pro	90° Boots	75051	75251	-	75051-B	75251-B
8mm Spiro Pro	135° Boots	75053	-	-	75053-B	75253-B
8mm Spiro Pro	180° Boots	75055	-	-	75055-B	75255-B
8.2mm ThunderVolt	135° Boots	-	-	85653	-	-

8.0mm TCW CORE PRO UNIVERSAL IGNITION WIRES

- 8.00mm Outer Silicone Jacket
- 0 ohms per foot resistance tin plated copper wire core (solid core)
- Heat resistant up to 600°
- Silicone inner core provides added heat protection and superior flexibility throughout its lifetime
- Recommended for Vertex® Magneto or point type ignition
- Not recommended for applications with onboard electronics or electronic ignition
- Universal fit sets will require cutting to fit, terminating, and booting the distributor end

Wire Config	Cyl	Black	Red	BLUE
90° Plug Boots	8	70050	70250	70650
135° Plug Boots	8	70052	70252	70652
180° Plug Boots	8	70054	70254	70654
331-426 Street Hemi	8	75087	-	-
90° Magneto	8	70060	70260	70660
180° Magneto	8	70064	70264	-

Universal Wire Set Lengths

4 cyl - 48, 36, 36, 36, coil 30
 6 cyl - 46, 44, 42, 30, 28, 28 coil 36
 8 cyl - 53, 53, 49, 49, 38, 38, 33, 33, coil 36
 Street Hemi - 61, 56, 51, 47, 35, 30, 29, 29, coil 36
 Magneto - 53, 53, 53, 53, 53, 53, 53, 53, coil 18

Race Fit Part Numbers
 TAP HERE (Page 9) →



8.0mm RESISTOR CORE PRO UNIVERSAL IGNITION WIRES

- 8.00mm Outer Silicone Jacket
- Heat resistant up to 600°
- 3500 ohms per foot resistor core
- Silicone inner core provides added heat protection and superior flexibility throughout its lifetime
- Eliminate RFI/EMI which can interfere with onboard electronics and stereos
- Not Recommended for CD ignitions
- Universal fit sets will require cutting to fit, terminating, and booting the distributor end

Wire Config	Cyl	Black	Red	Blue
180° Plug Boots	6	-	70245	-
90° Plug Boots	8	70051	70251	70651
135° Plug Boots	8	70053	70253	70653
180° Plug Boots	8	70055	70255	70655

Universal Wire Set Lengths

4 cyl - 48, 36, 36, 36, coil 30
 6 cyl - 46, 44, 42, 30, 28, 28, coil 36
 8 cyl - 53, 53, 49, 49, 38, 38, 33, 33, coil 36



8 HIGH ENERGY MM IGNITION WIRE SET

**The perfect choice for the daily driver.
OE replacement.**

8mm High Energy wires are the perfect choice for the daily driver and meet the demands of today's high-tech ignitions and high under hood temperatures.

- 8.0 mm Outer Silicone Blend Jacket
- Heat resistant to 600 Degrees
- Silicone inner core provides added heat protection throughout its lifetime
- 5000 ohms per foot resistor core
- Eliminates RFI /EMI which can interfere with onboard electronics and stereos
- Not recommended for CD ignitions
- High Temp Silicone Boots
- Double spring lock spark plug terminals
- Available in Blue only
- Universal Fit sets and will require cutting to fit, terminating, and booting the distributor end
- Available in Universal, Race Fit and Custom applications

8mm High Energy wires are engineered to deliver superior performance with unsurpassed quality.

Clamp Style Separators



Black: 42700
Red: 42720
Blue: 42760

Race Fit Part Numbers
TAP HERE (Page 9) →

TAYLOR HI-ENERGY 8mm WIRE

Universal Wire Set Lengths

8 cyl - 53, 53, 49, 49, 38, 38, 33, 33, coil 36
6 cyl - 46, 44, 42, 30, 28, 28, Coil 36

Wire Config	CYL	Blue
180° Plug Boots	6	60645
90° Plug Boots	8	60651
135° Plug Boots	8	60653
180° Plug Boots	8	60655

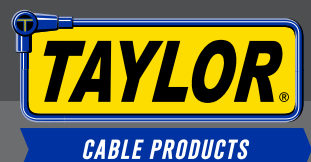

Firing America's Finest Rides Since 1923!

8mm STREETHUNDER IGNITION WIRE SET

For Street & Muscle Cars.

8mm StreeThunder wires feature a 500 ohm per foot resistance conductor wrapped in durable silicone blend double layer jacketing for heat protection, strength, and longevity.

They are the top choice amongst car enthusiasts with heat protection up to 600° F and 65,000 volts of dielectric strength.

- 8.0 mm Outer Silicone Jacket
 - Heat resistant to 600 Degrees
- Silicone inner core provides added heat protection throughout its lifetime
- 500 ohms per foot
- Highly conductive stainless steel spiral wound core
- Eliminates RFI /EMI which can interfere with onboard electronics and stereos
- Silicone boots protect against high exhaust temperatures
- Double spring lock spark plug terminals
- Available in Black only
- Universal Fit sets and will require cutting to fit, terminating, and booting the distributor end
- Available in Universal, Race Fit and Custom applications

8mm StreeThunder wires are designed to deliver great performance at an extremely affordable price.

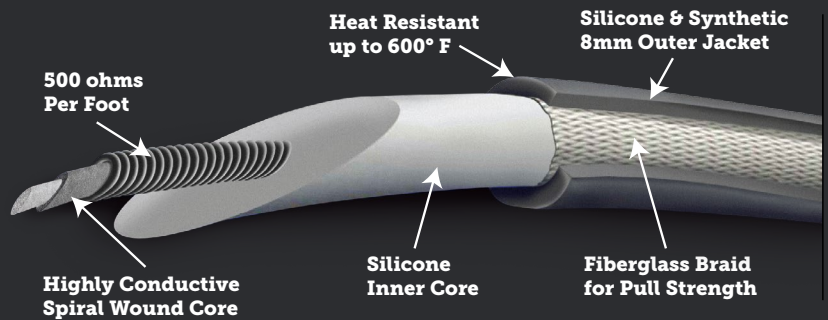

Universal Wire Set Lengths

4 cyl - 48, 36, 36, 36, coil 30
 6 cyl - 46, 44, 42, 30, 28, 28, coil 36
 8 cyl - 53, 53, 49, 49, 38, 38, 33, 33, coil 36

Wire Config	Cyl	Black
180° Plug Boots	4	50035
90° Plug Boots	6	50047
180° Plug Boots	6	50045
90° Plug Boots	8	50051
135° Plug Boots	8	50053
180° Plug Boots	8	50055

Race Fit Part Numbers
 TAP HERE (Page 9) →

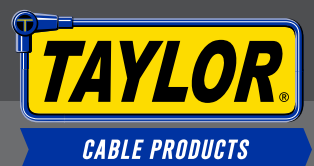

Firing America's Finest Rides Since 1923!

8.2 THUNDERVOLT[®] IGNITION WIRE SET

For Street & Strip, Off Road, Street Rod, and Custom Cars.

8.2mm ThunderVolt[®] wires outperform the competition in looks and performance at an affordable price.

- 8.2 mm Outer Silicone Jacket
 - Heat resistant to 600 Degrees
- Silicone inner core provides added heat protection and superior flexibility throughout its lifetime
- 40 ohms per foot
- Highly conductive stainless steel spiral wound core
- RFI / EMI suppression for applications with CD or electronic ignitions, on board computers, stereos, or pit radios
- Silicone boots protect against high exhaust temps
- Double spring lock spark plug terminals
- Available in Black, Red and Blue
- Universal Fit sets and will require cutting to fit, terminating, and booting the distributor end
- Available in Universal, Race Fit and Custom applications

Get the right tools for the job!



Spark Plug Wire Stripping Tool
T3004



Quick Change 6 Piece Ratchet Crimp Tool Kit
T3001

OR THUNDERVOLT 8.2mm WIRE

Universal Wire Set Lengths

4 cyl - 48, 36, 36, 36, coil 30
 6 cyl - 46, 44, 42, 30, 28, 28, coil 36
 8 cyl - 53, 53, 49, 49, 38, 38, 33, 33, coil 36
 Street Hemi: 61, 56, 51, 47, 35, 30, 29, 29 Coil 36
 Race Hemi: 72, 72, 60, 60, 48, 48, 36, 36 Coil 48

Wire Config	Cyl	Black	Red	Blue
180° Plug Boots	4	-	83235	-
180° Plug Boots	6	83045	83245	83645
90° Plug Boots	8	83051	83251	83651
135° Plug Boots	8	83053	83253	83653
180° Plug Boots	8	83055	83255	83655
331-426 Street Hemi	8	85089	-	-
Hemi-Race/Fathead	8	82092	-	-

Race Fit Part Numbers
TAP HERE (Page 9) →

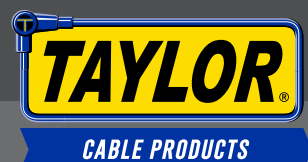

Firing America's Finest Rides Since 1923!

10.4 409 SERIES

HIGH PERFORMANCE PRO RACE
IGNITION WIRE SET

For Drag Race, Circle Track, Off Road or High Heat Applications.

10.4mm 409 Series Ignition Wires provide continuous heat protection up to 600° F and 102,000 volts of dielectric strength.

- 10.4 mm Outer Silicone Jacket
 - Rated up to 65K Volts
 - Heat resistant to 600 Degrees
- Silicone inner core provides added heat protection and superior flexibility throughout its lifetime
- 350 ohms per foot
- Highly conductive helically wound core
- Superior RFI / EMI suppression for applications with CD or electronic ignitions, on board computers, stereos, or pit radios
- Taylor low profile Silicone Pro Boots
- Double spring lock spark plug terminals
- Available in Black, Red and Blue
- Universal Fit sets and will require cutting to fit, terminating, and booting the distributor end
- Available in Universal, Race Fit and Custom applications

10.4mm 409 Series wires are engineered to deliver superior performance with unsurpassed quality.



Universal Wire Set Lengths

6 cyl - 46, 44, 42, 30, 28, 28, coil 36
 8 cyl - 53, 53, 49, 49, 38, 38, 33, 33, coil 36
 Hemi - 72, 72, 60, 60, 48, 48, 36, 36, coil 48

Wire Config	Cyl	Black	Red	Blue
180° Plug Boots	6	-	79245	79645
90° Plug Boots	8	79051	79251	79651
135° Plug Boots	8	79053	79253	79653
180° Plug Boots	8	79055	79255	79655
Hemi - Race/Fathead	8	79092	-	-

Race Fit Part Numbers
TAP HERE (Page 9) →

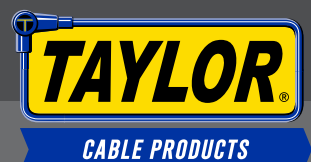

Firing America's Finest Rides Since 1923!

MOTORCYCLE IGNITION WIRE SET



- 100% Silicone Outer Jacket
 - Rated up to 65K volts
 - Heat resistant to 600°
- Silicone inner core provides added heat protection and superior flexibility throughout its lifetime
- Highly conductive stainless steel spiral wound core
- Taylor signature low profile Silicone Pro Boots on 8mm & 10.4mm wires
- Double spring lock spark plug terminals
- Available in Black, Red, and Blue

CUSTOM FIT

	Year & Model	Engine	Models	Plug Boots	Wire Lengths	8mm Spiro Pro			10.4mm 409 Race			10.4mm 409 Race		
						Black	Red	Blue	Black	Red	Blue	Black	Red	Blue
TOURING	2017+ FL	Milwaukee Eight	Road King, Electra Glide, Road Glide, Street Glide	135°/OE	17"/17"/30"/33"	10068	10268	10668	13068	13268	-	-	-	-
	09-16 FL	Twin Cam	Road King, Electra Glide, Road Glide, Street Glide	135°	35"/17"	10036	10236	-	13036	13236	13636	-	-	-
	99-08 FL	Twin Cam F.I.	Road King, Electra Glide, Road Glide, Street Glide	180°	21"/21"	10034	10234	-	-	13234	13634	-	-	12634
	99-06 FL	Twin Cam Carb	Road King, Electra Glide, Street Glide	180°	21.5"/9"	10033	10233	10633	13033	13233	-	-	-	-
	80-98-FLH	EVO	Electra, Road King, Street Glide	180°	21.5"/9"	10032	10232	10632	13032	13232	-	12032	-	-
	65-79-FL	EVO	Road King, Electra Glide, Road Glide, Street Glide	90°	16"/7"	10030	10230	10630	13030	13230	13630	-	-	-
SUPER GLIDE	99-07 FXD	Twin Cam	Dyna	90°	19"/7"	10031	10231	10631	13031	13231	13631	-	-	12631
	91-98 FXD	Evo	Dyna	90°	16"/7"	10030	10231	10630	13030	13230	13630	-	-	-
	82-00 FXR	Evo	Super Glide	90°	12"/12"	10035	10235	10635	13035	13235	13635	12035	12235	-
	65-85 FX	-	Super Glide, Dyna, FXR	90°	16"/7"	10030	10230	10630	13030	13230	13630	-	-	-
SOFTAIL	2018+ FL/FX	Milwaukee Eight	Fat Bob, Street Bob, Heritage Classic, Lowrider, Slim, Deluxe, Fat Boy	135°/OE	10"/10"/16"/16"	10037	10237	10637	13037	13237	-	-	-	-
	08-17 FXC	Twin Cam	Softail Rocker or center mount Twin Cam Coils	90°	8"/8"	10038	10238	10638	-	-	-	-	-	-
	00-11 FL/FX	Twin Cam	Softail (except Rocker)	90°	19"/7"	10031	10231	10631	13031	13231	13631	-	-	-
	89-99 FL/FX	Evo	Softail	90°	16"/7"	10030	10230	10630	13030	13230	13630	-	-	-
SPORTSTER	07-18 XL	Evo	Sportster	180°	21.5"/9"	10033	10233	10633	13033	13233	-	-	12263	12669
	04-06 XL	Evo	Sportster (except XL1200 S Model w/4 wires)	180°	21"/21"	10034	10234	-	-	-	-	-	-	-
	86-03 XL	Evo	Sportster (except XL1200 S Model w/4 wires)	180°	21"/9"	10032	10232	10632	13032	13232	-	-	-	-
	65-85 XL	Ironhead	Sportster	90°	16"/7"	10030	10230	10630	13030	13230	13630	-	-	-
	08-17	V-Twin	All, except Octane	180°	12"/20"	10063	10263	-	13063	-	-	-	-	-

UNIVERSAL

Wire Length	Wire Config	8mm Spiro Pro			Pro Resistor Black	Pro TCW Black
		Black	Red	Blue		
24	90° Plug Boots	10051	10251	10651	11055	11050
24	135° Plug Boots	10053	10253	-	-	-
24	180° Plug Boots	10055	10255	10655	-	-
36	180° Pro Comp	10085	-	10685	-	-

Boot and Terminal Kits, 4-Pack

90 EVO HEI/Socket Boot/Term MC Kit, Black	10005
Twin Cam LS/LT Boot/Terminal 90/180 MC Kit, Black	10006

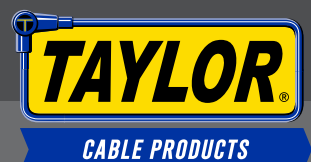

Firing America's Finest Rides Since 1923!



RACE FIT APPLICATION GUIDE



Race **FIT**

To select wire color, replace X in part # with:

0 = Black 2 = Red 6 = Blue

Engine	Plug Boot	Description	8mm Spiro Pro	Black Ceramic 8mm Spiro Pro	White Ceramic 8mm Spiro Pro	10.4mm 409 Pro Race	8.2mm ThunderVolt	Sleeved 8.2mm ThunderVolt	Black Ceramic 8.2mm ThunderVolt	8mm Pro TCW Wire Core	8mm StreetThunder	High Energy	1	2	3	4	5	6	7	8	Coil Wire
Chevrolet																					
Small Block	90°	Under Valve Cover HEI	74X06	-	-	-	-	-	-	-	-	64606	57	57	48	48	45	36	36	30	N/A
Small Block	90°	Over Valve Covers Socket	76X27	-	-	79X27	86X27	-	-	-	56027	-	37	37	33	33	27	27	24	24	36
Small Block	90°	Over Valve Covers HEI	76X28	75028-B	75228	79X28	86X28	86068	-	76X38	56028	-	38	34	31	31	25	23	23	23	36
Small Block	90°	Under Headers Socket	76X29	-	75029	79X29	86X29	-	-	-	56029	-	48	48	48	44	34	31	28	26	36
Small Block	90°	Under Headers HEI	76X30	75030-B	75030	79X30	86X30	86070	-	76X40	51006	-	41	40	37	36	30	29	29	27	36
Big Block	135°	Over Valve Covers Socket	76X31	-	-	79X31	86X31	-	-	-	56031	-	40	40	35	35	32	32	28	28	36
Big Block	135°	Over Valve Covers HEI	76X32	75032-B	75032	79X32	86X32	-	-	76X42	56032	-	41	38	34	32	28	28	25	22	36
Big Block	90°	Under Headers Socket	76X01	-	-	79X01	-	-	-	-	51013	-	42	41	34	34	31	28	24	23	36
Big Block	90°	Under Headers HEI	76X02	75002-B	75002	79X02	86X02	-	-	-	51012	-	45	42	38	38	37	34	31	27	36
LT1 / LT4	90°	Over Valve Covers Optispark	76X47	-	-	79X47	-	-	-	-	-	-	42	42	42	38	35	35	32	30	10
GM LS / LT Gen III / IV / V																					
LT / LS	135°	2014+ LT1 10.375" Headers	-	-	-	79X62	-	-	-	-	-	-	10.375	10.375	10.375	10.375	10.375	10.375	10.375	10.375	N/A
LS	135°	9.5" Car Header	76X45	75045-B	-	79X13	86X45	-	85045-B	-	51045	-	9.5	9.5	9.5	9.5	9.5	9.5	9.5	9.5	N/A
LS	135°	11.75" Truck Header	76X46	75046-B	-	79X14	86X46	-	85046-B	-	51046	-	11.75	11.75	11.75	11.75	11.75	11.75	11.75	11.75	N/A
LS	135°	14" Headers	-	-	-	79X18	86X18	-	-	-	-	-	14	14	14	14	14	14	14	14	N/A
LS	135°	16" Headers	-	-	-	79X17	86X17	-	-	-	-	-	16	16	16	16	16	16	16	16	N/A
Ford																					
Small Block	135°	Over Valve Covers DSI	76X58	75058-B	75058	79X58	-	-	-	-	56058	-	35	35	32	29	26	25	23	21	36



Firing America's Finest Rides Since 1923!



COIL BOOTS & TERMINALS

LS ENGINES Coil Boots & Terminals



46067



46069



46052

LS Coil Boots & Terminals	Qty	Part #
90° LS Coil	10	46067
135° LS Coil	8	46069
180° LS Coil	10	46052

SMART Coil Boots & Terminals



46001



46005

Smart Coil Boots & Terminals	Qty	Part #
90° LS Coil	8	46001
135° LS Coil	8	46005
180° LS Coil	8	46003



46003

IGNITION REPAIR PARTS

SPARK PLUG & COIL WIRE REPAIR KITS

- Taylor repair wire kits provide easy replacement for damaged wires
- 90°/180° repair wire kits are 54" and have 90° plug boot on one end and 180° plug boot on the other end
- 135° repair wire kits have terminal and boot on one end only
- HEI and socket style distributor ends provided in kits
- LT1 kit comes with the Opti-Spark connector installed - 90° spark plug and HEI boot and terminal are included
- Coil wire kits are 36" and come with all components required for HEI or socket style distributors and coils
- LS repair wires are pre-assembled with 135° coil connectors

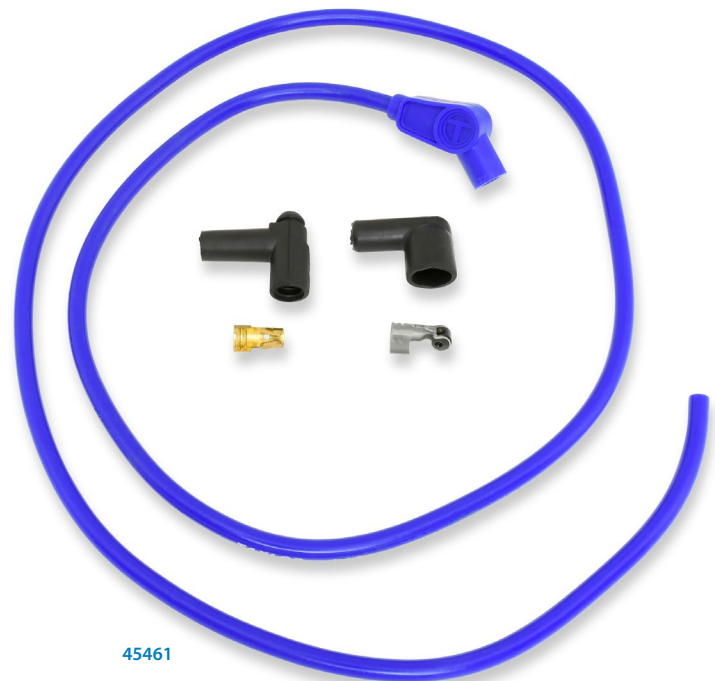

45461

Find Your Part #
on Page 11

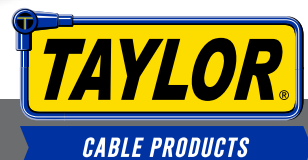

IGNITION REPAIR PARTS

409 Pro Race 10.4mm

Description	Black	Red	Blue
90°/180° Plug Boot - Universal	45903	45923	-
135° Plug Boot - Universal	45901	45921	-
Coil Wire Kit - Universal	45909	45929	45969
LS 9.5" - 135° Plug Boot	-	44922	-
LS 9.75" - 135° Plug Boot	-	-	44964

Spiro Pro 8mm

Description	Black	Red	Blue
90°/180° Plug Boot - Universal	45403	45423	45463
135° Plug Boot - Universal	45401	45421	45461
Coil Wire Kit - Universal	45409	45429	45469
331-426 Hemi - Universal	45406	-	-
LS 9.5" - 180° Plug Boot	-	-	45467
LT-1 Optispark 180° Plug/Dist	-	45425	-

High Energy 8mm

Description	Resistor
Coil Wire Kit - Universal (Blue)	45269

ThunderVolt 8.2mm

Description	Black	Red	Blue
90°/180° Plug Boot - Universal	45103	45123	45163
135° Plug Boot - Universal	-	-	45161
Coil Wire Kit - Universal	45109	45129	45169
LS 9.75" - 180° Plug Boot	45108	-	-

ThunderVolt 8.2mm - White Ceramic

Description	Black
90° Plug Boot - Universal	45603

8mm TCW Core Pro Series

Description	Black	Red	Blue
90°/180° Plug Boot - Universal	45300	45320	45360
135° Plug Boot - Universal	-	-	-
Coil Wire Kit - Universal	45306	-	45366

8mm Resistor Core Pro Series

Description	Black	Red	Blue
90°/180° Plug Boot - Universal	45303	-	-
135° Plug Boot - Universal	45304	-	45364
Coil Wire Kit - Universal	45309	45329	45369

BULK IGNITION WIRE



35642

30 ft. Coils

Description	Black	Red	Blue	Yellow	Purple	Orange	Lime	Gray	Pink
8mm Spiro Pro Spiral-Wound	35071	35271	35671	35471	35191	35891	35591	35874	35791
8mm TCW Core	35081	35281	35681	-	-	-	-	-	-
409 Pro Race Spiral-Wound	36071	36271	36671	-	-	-	-	-	-

100 ft. Spools

Description	Black	Red	Blue	Yellow	Purple	Orange	Lime	Gray	Pink
8mm Spiro Pro Spiral-Wound	35072	35272	35672	35472	35172	35372	35572	35875	35792
8mm Pro TCW Core	35082	35282	35682	-	-	-	-	-	-
8mm Pro Resistor Core	35092	-	-	-	-	-	-	-	-
409 Pro Race Spiral-Wound	36072	36272	36672	-	-	-	-	-	-
8mm High Energy Resistor Core	-	-	35652	-	-	-	-	-	-



Firing America's Finest Rides Since 1923!

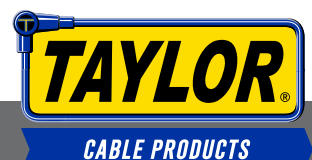

IGNITION REPAIR PARTS

SPARK PLUG BOOTS AND TERMINALS

- Blue, black or gray high temperature 8mm silicone spark plug boots
- Vibration proof spring lock spark plug terminals
- Complete boot/terminal kits and bulk packages for engine builders
- All boot/terminals fit 8-10.4mm

Description	Qty	Blue	Black	Gray
90° Spark Plug Boot/Terminal Kit	8	46061	46001	46081
135° Spark Plug Boot/Terminal Kit	8	46065	46005	46085*
180° Spark Plug Boot/Terminal Kit	8	46063	46003	46083
90° Silicone Boots	25	44796	46201	46181
135° Silicone Boots	25	44806	46205	46185*
180° Silicone Boots	25	44696	46203	46183
90° Spark Plug Terminal	50	44409	-	-
135° Spark Plug Terminal	50	44389	-	-
180° Spark Plug Terminal	50	44399	-	-



*Gray boots are 115°

CHRYSLER HEMI

- Fits 331-426 Hemi engines
- Molded from OE Chrysler 426 Hemi tooling
- Assembled length 5"
- Fits 8-8.2mm wire
- Sold in sets of 8
- All kits 8/package



Street Hemi Tubes	Part #
8mm Tube only	44800
8mm Boots and Terminal	44500
8mm Well Cover	44300



44500



44300

Chrysler & Hemi are Trademarks of the Daimler-Chrysler Corp

DISTRIBUTOR/COIL BOOTS & TERMINALS

All boots & terminals fit 8-10.4mm wires except as noted with an asterisk (*)



46055



46059



46069



46052

Distributor & Coils Kits	Qty	Part #
90° HEI Distributor Boot/Terminal Kit, w/ holdown	9	46055
180° HEI Boot/Terminal Kit	9	46068
90° Low Profile HEI Distributor Boot/Terminal Kit, w/o holdown	11	46051
180° LS Coil/Optispark/Vortec Boots w/ Terminals	10	46052
135° LS Coil/Optispark/Vortec Boots w/ Terminals	8	46069
90° LS Coil/Optispark/Vortec Boots w/ Terminals	10	46067
180°/90° Impala SS/Camaro SS Optispark (5 ea.) Boots w/ Terminals	10	46066
90° Distributor & Coil Boot/Terminal Kit, 7-9mm - Socket Style	10	46057*
90° Distributor Boot/Terminal Kit, 10.4mm - Socket Style	9	46053*
180° Distributor & Coil Boot/Terminal Kit - Socket Style	10	46059
90° Coil Boot/Terminal Kit - Socket Style	1	46056
180° Coil Boot/Terminal Kit - Socket Style	1	46058

Bulk Pack Distributor & Coil Components	Qty	Part #
Boots		
90° HEI Distributor Boots w/ Holdown	25	44056
90° Distributor Boots - Socket Style	50	44166
180° Distributor Boots - Socket Style	50	44029
90° Coil Boots - Socket Style	25	44066
180° Coil Boots - Socket Style	25	44076
Terminals		
90° Distributor Spring Lock Terminals for HEI	50	44409
90° Distributor/Coil Terminals - Socket Style	25	44216
180° Distributor/Coil Terminals - Socket Style	100	44301

Note: Taylor's exclusive PROBOOTS® are not sold separately - see Spark Plug Repair Kits.

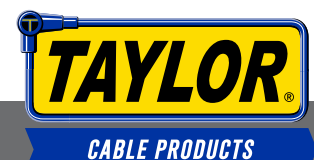

Firing America's Finest Rides Since 1923!

WIRE INSTALLATION TOOLS

PROFESSIONAL WIRE CRIMP TOOL

Hardened steel frame and orange molded cushion grips with positive ratcheting system that adjusts to produce a factory quality crimp each and every time. Optional 22-10 ga. insulated and non-insulated wire dies available.

Description	Part #
Crimpers - with ignition wire die only	43400
Die: 22-10 Gauge Insulated wire	43401



MULTI-PURPOSE PRO WIRE TOOL

- Made of high carbon steel, cuts and strips automotive primary wire, 22-10 ga.
- Crimps insulated and non-insulated solderless terminals
- Crimps 7-10.4mm spark plug terminals
- Cushioned PVC non-conductive handle grips

Description	Part #
Pro Wire Tool	43390



LOOMS & SEPARATORS

CLAMP STYLE SEPARATOR KITS

- Separates, organizes & supports ignition wires
- Provides a neat professional look
- Nylon separators are molded from a non-conductive type 6/6 material
- Will not melt, mar, distort, crack or fade
- Available for 7-8mm, 9mm, and 10.4mm wire sizes
- Stainless Steel hardware included

Each kit contains:

- 2 each - 4 wire separator
- 2 each - 3 wire separator
- 2 each - 2 wire separator

Separator Wire Size	Nylon Black	Nylon Red	Nylon Blue
7-8mm Kit	42700	42720	42760
10.4mm Kit	42709	42729	42769



LOOMS & SEPARATORS

MOUNTING BRACKETS FOR CLAMP STYLE WIRE SEPARATORS



42701

- Mounts Clamp Style Separators to valve covers
- Available in horizontal and vertical mounting styles
- Small Block kits contain 4 brackets per package
- Choice of 3 colors, made of type 6/6 nylon
- Fits 7-8mm and 10.4mm Clamp Style Wire Separators

Description	Black	Red	Blue
Horizontal			
Small Block Chevy & Most Chrysler, 4/pkg	42701	42721	42761
Big Block Chevy & Most Ford, 6/pkg	42702	-	42762
Vertical			
Small Block Chevy & Most Chrysler, 4/pkg	42705	42725	42765
Big Block Chevy & Most Ford, 6/pkg	42706	42726	42766

V-8 VERTICAL WIRE LOOM KITS

- This wire loom kit allows the wires to be run vertically close to the valve cover and away from the exhaust manifold heat
- This kit will fit applications where the valve covers are held on with outside fasteners 1/4-20
- Each kit contains 2 each: -2 Wire Separator, -3 Wire Separator, -4 Wire Separator and 6 Vertical brackets

Description/Wire Size	Black	Red	Blue
7-8mm Wire Loom Kit	42502	42522	42562
10.4mm Wire Loom Kit	42503	42523	42563

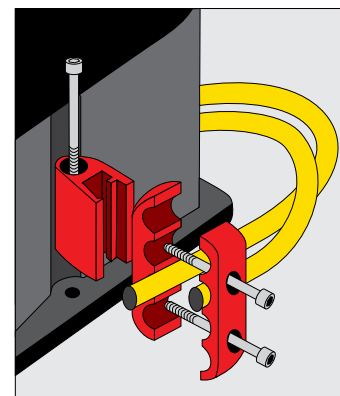

V-8 HORIZONTAL WIRE LOOM KITS

- This wire loom kit allows the wires to be run horizontal to the valve cover showing more of your wire set
- This kit will fit applications where the valve covers are held on with outside fasteners 1/4-20
- This kit will fit valve covers with center bolts such as late model Chevrolets, but will require longer valve cover bolts (longer bolts are NOT included)
- Each kit contains 2 each: -2 Wire Separator, -3 Wire Separator, -4 Wire Separator and 6 Horizontal brackets

Description/Wire Size	Black	Red	Blue
7-8mm Wire Loom Kit	42500	42520	42560
10.4mm Wire Loom Kit	42501	42521	42561

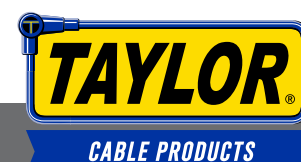
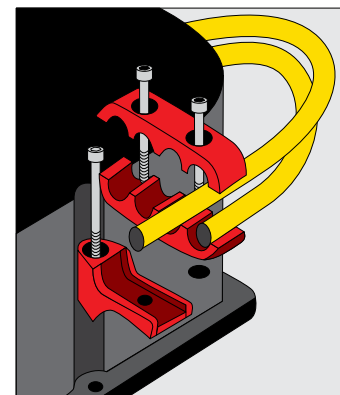

LOOMS & SEPARATORS

V-6 HORIZONTAL WIRE LOOM KITS

- This is a universal wire separator kit that is designed to fit all V-6 ignition wire applications
- Each kit contains: 2 each -2 Wire Separator, 4 each -3 Wire Separator, and 2 horizontal brackets



Description/Wire Size	Black
7-8mm Wire Loom Kit	42504

4 CYLINDER WIRE LOOM KITS

- This is a universal wire separator kit that is designed to fit all 4 cylinder ignition wire applications including Imports
- Each kit contains: 2 each - 4 wire Separator, 1 each - 3 wire Separator, 3 each - 2 wire Separator



Description/Wire Size	Black	Blue
7-8mm Wire Loom Kit	42506	42566
10.4mm Wire Loom Kit	42507	42567

ALUMINUM MOUNTING BRACKETS

- These aluminum brackets allow you to mount a vertical wire loom kit to the heads to leave your valve covers free from clutter and allow you to remove the valve covers without plug wire interference
- Kit contains 4 aluminum brackets only

Description	Part #
Aluminum Side Mount Brackets	42600



SHRINK SLEEVES & WIRE MARKERS

HEAT SHRINK SLEEVES

- Use to insure a complete seal between wire and spark plug/distributor boot
- Fits 7-9mm and 10.4mm spark plug wires
- Can be used on many other applications
- 10 per package

Wire Size	Black
7-10.4mm Wires	41056



SHRINK SLEEVE WIRE MARKERS

- Use on 7, 8, 9 and 10.4mm wire
- Black heat shrink sleeve wire identification markers with white numbers
- 2 sets of numbers, 1 through 8; enough for both ends of each wire



Wire Size	Black
7-10.4mm Wires	41058

CLIP-ON WIRE MARKERS

- Fits all 7 - 9mm & 10.4mm ignition wires
- White nylon clips with black numbers
- 2 sets of numbered clips, 1 through 8

Wire Size	Black
7-10.4mm Wires	41060



HEAT PROTECTION



SPACE AGE BOOT PROTECTORS

- Available in six wire matching colors
- 6" long, heat treated fiberglass
- Withstands temperatures up to 1200° F
- Slides over most plug boots and installs best on Universal Sets prior to final boot termination
- Retaining ring prevents the sock from coming off once installed
- Boot protectors packaged individually or in 8 packs

Qty	Yellow	Black	Silver	Orange	Blue	Red
1/Pkg	-	2559	2523	-	2565	2571
8/Pkg	2574	2560	2524	2568	2566	2572

FIRE SLEEVE BOOT PROTECTORS

- 6" long silicone covered braided fiberglass sleeve
- Continuous protection up to 500° F
- Slides over most plug boots
- Great for motor homes

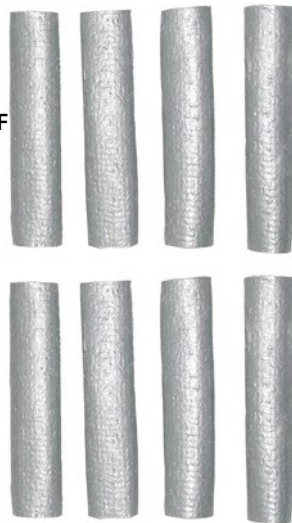

Qty	Silver
8/pkg	2522

HIGH PERFORMANCE 8" PLUG BOOT HEAT PROTECTORS

- Extended sleeve prevents damage from radiant heat
- 8" long heat treated fiberglass sleeve
- Withstands temperatures up to 1200° F
- Retaining ring prevents the sock from coming off once installed
- Slides over most spark plug boots and installs best on Universal Sets prior to boot termination

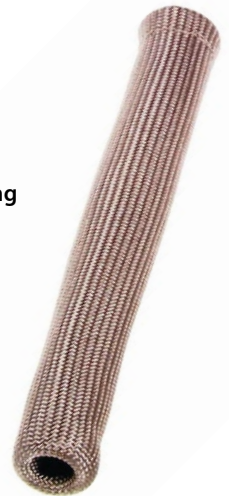

Qty	Silver
1/pkg	2526
8/pkg	2528

90° SPACE AGE BOOT PROTECTORS

- Open on both ends (no ring) so it can be installed on assembled wires without removing the boots
- Available in 4 colors
- 6" long, heat treated fiberglass
- Withstands temperatures up to 1,200° F

Qty	Black	Red	Blue	Silver
1/Pkg	2409	2411	-	2417
8/Pkg	2410	2412	2416	2418

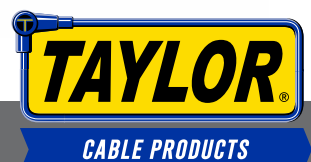

HEAT PROTECTION



THERMAL PROTECTIVE SLEEVING

Add cool protection to your hot rod or custom ride. An excellent way to protect wires, fuel lines, brake lines, and more while enhancing its overall appearance. This special weave of sleeving expands to allow easy installation over fittings, yet returns to original size. Coating makes it capable of withstanding 1200° F continuous temps. Rolls are 25' in length with an expanding I.D. diameter from 1/4" to 7/16", up to 8.2mm ignition wire.

Black	Red	Blue
2580	2582	2586

PRO-TECT PLUGWIRE SLEEVING

- Provides additional heat, abrasion, and dielectric strength
- Tightly woven fiberglass innermesh braid
- Fits 7mm and 8mm wire only
- Withstands temperatures up to 1200°F
- 100% silicone outer shell
- Brilliant red, 25 ft. roll

Red
2525



THUNDERVOLT® S-50 BLACK WIRE SLEEVING

- Extends Spark Plug Wire life by adding extra insulation against header heat
- Fiberglass shielding adds extra insulation and heat protection up to 600°F
- Black 25 ft. roll, up to 9mm ignition wire



Black
2529

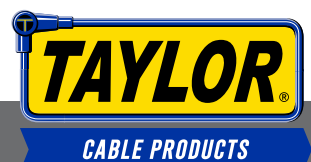

BATTERY & ELECTRICAL

OPTIMA BATTERY BILLET ALUMINUM TRAYS

- Upgrade the look of your Optima Battery to a full custom look
- Fits Optima Blue, Red, and Yellow top batteries as listed
- Ball-Milled Billet Aluminum with a high polish finish for a smooth custom look
- 3 piece Modular design, light weight & durable



Group 34/78 Optima Battery

Overall Dimensions
11.5"L x 7.75"W x 7.325"H

- Includes top plate, bottom base, mounting spacers and 4 flat head socket cap screws
- Bottom base has multiple mounting holes

Description	Part #
Group 34/78 Optima Battery	48220

Optima Aluminum Battery Box - 200 Series

- Fits Odyssey PC1500 series, Optima® Redtop and Yellowtop and most group 34/78 and 75/25 batteries
- 3 piece .040" aluminum box design allows access without removing the battery from the box
- Complies with NHRA Rule 8:1
- Hard mounts battery to the frame with supplied 3/8" bolts
- Heavy duty one-piece welded battery hold down with spacers to accommodate different widths
- All mounting hardware included
- Dimensions: 11.25" long x 9.5" wide x 8.75" high
- Kits with cable include 16 ft. positive and 20" negative battery cable



Description	Part #
Battery Box and Hold Down Components	48200
Battery Box with 2 ga. Battery Cable Kit	48201

Description	Part #
Battery Box with 1 ga. Battery Cable Kit	48203
Battery Box with 1 ga. Welding Cable Kit	48204

BATTERY & ELECTRICAL

Aluminum Battery Box - 100 Series

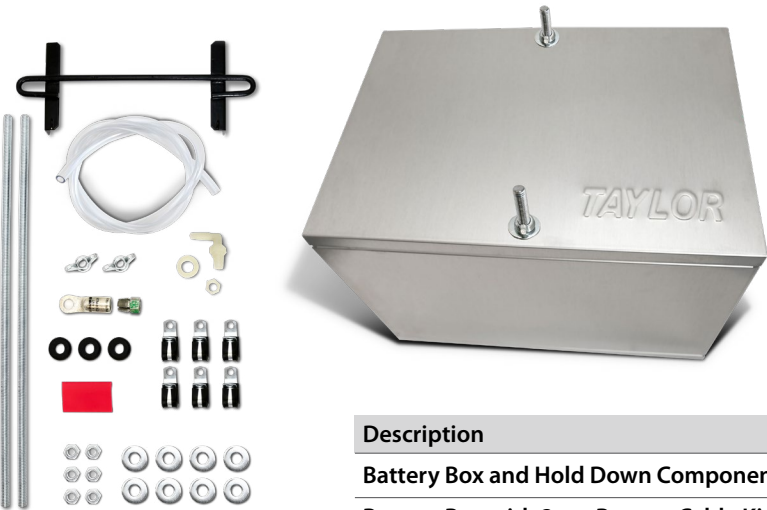

- Complies with NHRA Rule 8:1
- Fits most battery sizes
- 3 piece .040" aluminum box design allows access without removing the battery from the box
- Hard mounts battery to the frame with supplied 3/8" bolts
- Heavy duty one-piece welded battery hold down and mounting hardware included
- Dimensions: 13.5" long x 9.5" wide x 10" high
- Kits with cable include 16 ft. positive and 20" negative battery cable

Description	Part #	Description	Part #
Battery Box and Hold Down Components	48100	Battery Box with 1 ga. Battery Cable Kit	48103
Battery Box with 2 ga. Battery Cable Kit	48101	Battery Box with 1 ga. Welding Cable Kit	48104
Heavy Duty "H" Bar Battery Hold Down	48102		

Odyssey Aluminum Battery Box - 300 Series



- Fits Odyssey PC925 and PC1200 series batteries
- 3 piece .040" aluminum box design allows access without removing the battery from the box
- Not applicable with NHRA Rule 8:1
- Ideal for street rods, customs, and race applications where space is limited
- Hard mounts battery to the frame with supplied 5/16" bolts
- Comes with 2 piece molded adjustable battery hold down
- All mounting hardware included
- Dimensions: 9.5" long x 8.25" wide x 7.75" high
- Kits with cable include 16 ft. positive and 20" negative battery cable

Description	Part #
Battery Box and Hold Down Components	48300

Single Trunk Mount Battery Relocator Kit

- Factory crimped terminals on 100% copper cables
- 16' red 2 gauge cable, battery to starter
- 20" black 2 gauge cable, battery to ground
- 13" x 7.25" heavy gauge coated steel tray
- 3/8" J bolts and hold down with installation hardware included

Description	Part #
Battery Tray with 2 ga. Battery Cable	48000
Battery Tray with 1 ga. Battery Cable	48010
Battery Tray with 1 ga. Welding Cable	48020

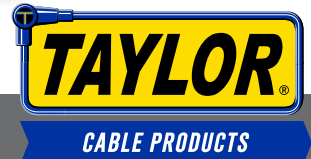

BATTERY CABLE KITS

Battery Cable Kits – 1/0 Gauge Welding Cable

- 1026 strands of premium 30 gauge Copper Wire as our largest battery cable to deliver more cranking power with less voltage drop than other battery cables
- Features Crimped Tin Plated Brass top post Terminals on both cable ends; 1-positive, 1-negative (3x more conductive than lead and less corrosive)
- Includes Copper Ring Terminals for Starter and Ground connections
- Comes complete with “P” Clip Cable Mounts and Shrink Sleeve tubing for a professional finish

Description	Black	Red
1/0 ga. 8-ft Kit	21543	21541
1/0 ga. 20-ft Kit	21542	21540



Thru-Panel Battery Connector

Description	Part #
1/pkg.	21502



- Ideal for a battery or charging cable passing through a firewall or panel
- Solid brass 3/8 inch threaded stud
- Fits 1-1/4 inch hole, held in place by spanner nut - 6-36VDC
- Available only in black

Battery Cable Terminal Kits

- These tin plated copper compression battery cable terminals are designed for a fast and easy install
- Simply strip your battery cable and apply fitting to cable and screw into battery terminal
- Terminals and compression fittings are cadiumplated for corrosion resistance

Description	Part #
2-1 ga. Battery terminal 2/pkg	21405
2-1 Ga Battery Eyelet Terminal 2/pkg	21409
1/0 Battery terminal 1/pkg	21412
1/0 Battery eyelet terminal 1/pkg	21414



Battery Accessories

Description	Part #
Battery Terminal Covers, 4-6 ga. 1-red/1-black	20670
J Battery Hold Down Bolts, 1 Pair	21982
Wing Nuts Zinc Plated, 3/8 x 10 inch	

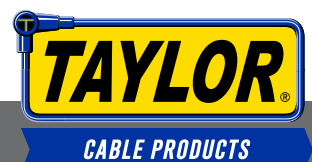

MASTER DISCONNECT SWITCHES

The Switch



- A practical electrical master cutoff switch for safety and security
- 3/8 in. posts - rated capacity 150 amps/24 volts continuous service - 500 amps/10 seconds
- Removable key

Description	Part #
Switch only	1036
Switch with Aluminum Mounting Bracket	1037

Toggle Switch



- 50 amp - heavy duty die cast housingscrew terminal - fits 1/2" hole

Description	Part #
Toggle Switch	1018

Waterproof Sealed Switches

- A must for any type of racing where switches may be exposed to moisture and dust
- Switches have internal "O" rings and plasticized bodies to protect against moisture, dust and vibration.
- Rated at 25 amps



Description	Part #
Waterproof Sealed Switches	1026

Push Button Starter Switch

- Used for interior or engine compartment mounting
- Neoprene cap seals out dust and moisture
- Rated at 60 amps, 12 VDC
- Features silver contacts
- 5/8" hole size



Description	Part #
Push Button Starter Switch	1016

2-Post Switch



- Designed to provide a direct power cutoff of the entire electrical system
- Required on all NHRA Modified and Super Stock classes
- Mandatory per NHRA Rule 8:4
- 3/8 inch posts, 180 amps cont. / 1,000 intermittent
- Especially useful during battery charging

Description	Part #
1/pkg.	1032

4-Post Switch

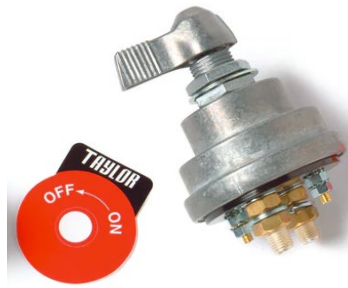

- Has 2 additional terminals for relay, magneto, etc. hookups
- Designed to provide a direct power cutoff of the entire electrical system
- Required on all NHRA Modified and Super Stock classes
- Power cut off required per NHRA Rule 8:4
- 3/8in. posts, 180 amps cont. / 1000 intermittent
- 3/16in post 20 amp max

Description	Part #
1/pkg.	1033

Power Plugs

- Provides instant quick and safe connection for auxiliary power sources
- Use for starting vehicle or quick charging the battery
- Fits wires up to 2 gauge, 175 amps rating

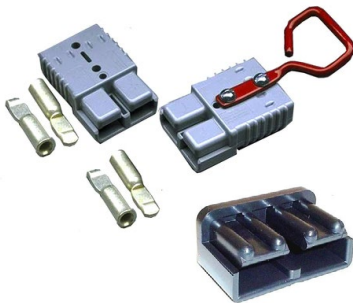

Description	Part #
Power Plug Kit, set includes handle & 4 terminals	21518
Power Plug Dust Cover, optional-not included in kit	21520

4 Gauge Grounding Strap

- 12/32" eyelet hole
- Fits 3/8" stud
- 4 awg tinned copper wire
- Strap 1" x 3/32"



Description	Part #
4 ga. Grounding Strap - 8" long	20308
4 ga. Grounding Strap - 14" long	20314
4 ga. Grounding Strap - 18" long	20318

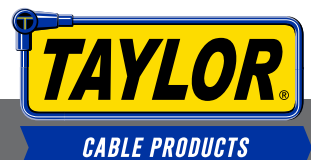

CUSTOM WIRE SETS APPLICATION GUIDE

To select wire color, replace X in part # with:

0 = Black 2 = Red 6 = Blue

Check Availability - Not all part numbers currently available in all colors.

Begin Year	End Year	Model	Engine	Street Thunder	High Energy Resistor Core	8mm Spiro Pro	White Ceramic Spiro Pro	Black Ceramic Spiro Pro	Thunder Volt 8.2	Black Ceramic 8.2mm	409 Pro Race	Plug Boot Angle	Coil Wire Length
AMC													
6 Cylinder													
1978	1988	All Models	232-3.8L, 258-4.2L	51047	64647	74X47	-	-	84X47	-	-	180/90	9
8 Cylinder													
1968	1979	All (w/HEI Distributor)	ALL	51004	64604	74X04	-	-	84X04	-	-	135	12
1968	1979	All (w/Conventional Distributor)	ALL	51003	64603	74X03	-	-	84X03	-	79X31	135	18
1962	1967	All Models	ALL	51052	64652	74X52	-	-	84X52	-	79X65	180	14/15
1957	1961	All Models	ALL	51051	64651	74X51	-	-	84X51	-	79X79	180	14/14
1955	1956	All Models	ALL	51052	64652	74X52	-	-	84X52	-	79X65	180	14/15
BUICK													
6 Cylinder													
2009	2010	Lucerne	3.9L (1) (M)	53048	-	-	-	-	82X48	-	-	OE	NR
2005	2009	LaCrosse, Lucerne	3.8L (2)	53010	-	72X10	-	-	82X10	-	-	180	NR
2005	2009	Allure	3.6L, 3.8L (2)	53010	-	72X10	-	-	82X10	-	-	180	NR
2006	2007	Terraza	3.9L (1) (W)	53048	-	-	-	-	82X48	-	-	OE	NR
2005	2007	Rendezvous, Terraza	3.5L (L) (8)	53047	-	-	-	-	82X47	-	-	OE	NR
2003	2005	Rendezvous	3.4L (E)	53000	-	72X00	-	-	82X00	-	-	180	NR
1995	2005	Century (97-98), Regal, Skylark	3.1L M, 3.4L (E)	53000	-	72X00	-	-	82X00	-	-	180	NR
1997	2004	Regal GS (Supercharged)	3.8L (1)	53006	-	72X06	-	-	82X06	-	-	180	NR
1996	2004	Regal (Except Supercharger)	3.8L (K)	53010	-	72X10	-	-	82X10	-	-	180	NR
1996	2003	Park Ave. & Riviera (Supercharged)	3.8L (1)	-	-	-	-	-	82X13	-	-	180	NR
1994	1994	Skylark	3.1L (M)	53000	-	72X00	-	-	82X00	-	-	180	NR
1992	1992	LeSabre, Park Avenue (Magnavox Ign.)	3.8L (1)	-	-	-	-	-	84X40	-	-	180	NR
1992	1992	Regal, Riviera (Magnavox Ign.)	3.8L	-	-	-	-	-	84X40	-	-	180	NR
1991	1991	Electra, LeSabre, Park Ave	3.8L (C, L)	-	-	-	-	-	84X40	-	-	180	NR
1988	1990	Electra, LeSabre, Riviera	3.8L	-	-	-	-	-	84X40	-	-	180	NR
1986	1987	Grand National (Turbo)	3.8L (7)	-	-	74X24	-	-	84X24	-	79X24	180	18
1986	1987	Regal (Non-Turbo)	3.8L (A)	51000	64600	74X00	-	-	84X00	-	-	180	16
1984	1986	Century	2.8L, 3.0L	51000	64600	74X00	-	-	84X00	-	-	180	16
1985	1985	Skylark (w/High-Output, w/EFI)	2.8L (W)	-	-	74X24	-	-	84X24	-	79X24	180	18
1984	1985	Skylark (non High-Output)	2.8L (X)	51000	64600	74X00	-	-	84X00	-	-	180	16
1984	1985	LeSabre, Regal, Riviera	3.8L	51000	64600	74X00	-	-	84X00	-	-	180	16
1982	1984	Electra, LeSabre, Regal, Riviera	3.8L, 4.1L	51000	64600	74X00	-	-	84X00	-	-	180	16
1983	1983	Century, Skylark	2.8L, 3.0L	51000	64600	74X00	-	-	84X00	-	-	180	16
1982	1982	Century	2.8L	51000	64600	74X00	-	-	84X00	-	-	180	16
1980	1981	All Models	2.8L, 3.8L, 4.1L	51000	64600	74X00	-	-	84X00	-	-	180	16
1978	1979	All Models (Except Turbos)	196, 231	51000	64600	74X00	-	-	84X00	-	-	180	16
1975	1977	All Models	231	51000	64600	74X00	-	-	84X00	-	-	180	16
8 Cylinder													
2008	2009	Allure	5.3L LS4 (C)	53044	-	72X44	-	-	82X44	-	79X06	OE	NR
2009	2009	LaCrosse Super	5.3L LS4 (C)	51044	-	74X44	-	75044-B	84X44	85044-B	79X03	180	NR
2008	2008	LaCrosse Super	5.3L LS4 (C)	53044	-	72X44	-	-	82X44	-	79X06	OE	NR
2005	2007	Rainer	5.3L (M)	53044	-	72X44	-	-	82X44	-	79X06	OE	NR
1994	1996	Roadmaster	5.7L (P) LT1	-	-	74X27	-	-	84X27	-	79X04	90	11/12
1992	1993	Roadmaster	5.7L (7)	51011	64611	74X11	-	-	84X11	-	-	90/180	10
1991	1991	Roadmaster	5.0L (E)	51011	64611	74X11	-	-	84X11	-	-	90/180	10
1983	1990	LeSabre, Riviera	5.0L (Y)	51004	64604	74X04	-	-	84X04	-	79X32	135	12
1986	1987	Regal	5.0L (Y)	51004	64604	74X04	-	-	84X04	-	79X32	135	12
1985	1987	Regal	5.0L (H)	51007	64607	74X07	-	-	84X07	-	-	90/135	NR
1983	1984	Regal	5.0L	51007	64607	74X07	-	-	84X07	-	-	90/135	NR
1981	1982	Century, Electra, LeSabre, Regal	4.4L	51007	64607	74X07	-	-	84X07	-	-	90/135	NR
1981	1982	Electra, LeSabre, Riviera	5.0L	51004	64604	74X04	-	-	84X04	-	79X32	135	12
1979	1981	Century, Electra	4.3L, 4.9L	51016	64616	74X16	-	-	84X16	-	-	180/135	NR
1980	1980	Century	5.0L	51007	64607	74X07	-	-	84X07	-	-	90/135	NR
1980	1980	Electra, Riviera	5.7L (R, X)	51004	64604	74X04	-	-	84X04	-	79X32	135	12
1979	1979	Century, Regal	5.7L (L)	51007	64607	74X07	-	-	84X07	-	-	90/135	NR
1979	1979	Skylark	5.0L, 5.7L (L)	51002	64602	74X02	-	75028-B	84X02	-	79X28	90	10
1979	1979	Electra, LeSabre, Riviera	5.7L (R, X)	51004	64604	74X04	-	-	84X04	-	79X32	135	12
1979	1979	Electra, LeSabre	403	51004	64604	74X04	-	-	84X04	-	79X32	135	12
1978	1978	Century	305	51007	64607	74X07	-	-	84X07	-	-	90/135	NR
1978	1978	LeSabre	350 (R, X)	51004	64604	74X04	-	-	84X04	-	79X32	135	12
1977	1978	Century, LeSabre	301	51016	64616	74X16	-	-	84X16	-	-	180/135	NR
1977	1978	Century, Electra, LeSabre, Skyhawk	305, 350 (L)	51002	64602	74X02	-	75028-B	84X02	-	79X28	90	10
1977	1977	All Models	350 (H, J, R)	51004	64604	74X04	-	-	84X04	-	79X32	135	12
1977	1977	All Models	403	51004	64604	74X04	-	-	84X04	-	79X32	135	12
1976	1976	All Models	260, 350, 400	51004	64604	74X04	-	-	84X04	-	79X32	135	12
1973	1974	All Models (w/HEI)	350	51004	64604	74X04	-	-	84X04	-	79X32	135	12
1967	1974	All Models (non HEI)	350, 455	51014	64614	74X14	-	-	-	-	-	180/135	11
1966	1966	All Models	400	51051	64651	74X51	-	-	84X51	-	79X79	180	14/14
1966	1966	All Models	300, 340, 401	51071	64671	74X71	-	-	84X71	-	-	180	14/25
1961	1965	All Models	215, 425	51052	64652	74X52	-	-	84X52	-	79X65	180	14/15
CADILLAC													
6 Cylinder													
1985	1986	Cimarron	173, 2.8L (W)	-	-	74X24	-	-	84X24	-	79X24	180	18
1980	1983	All Models	252, 4.1L	51000	64600	74X00	-	-	84X00	-	-	180	16
8 Cylinder													
2016	2017	CTS-V (Supercharged)	6.2L LT4 Supercharged	-	-	72X61	-	-	82X61	-	79X61	180	NR
2015	2017	Escalade / Escalade ESV	6.2L LT1	-	-	72X61	-	-	82X61	-	79X61	180	NR
2009	2015	CTS-V (Supercharged)	6.2L LSA(P)	51044	-	74X44	-	75044-B	84X44	85044-B	79X03	180	NR
2007	2014	Escalade, ESV, EXT	6.0L (5), 6.2L (8)	51044	-	74X44	-	75044-B	84X44	85044-B	79X03	180	NR
2006	2007	CTS V	6.0L LS2 (U)	53044	-	72X44	-	-	82X44	-	79X06	OE	NR



Firing America's Finest Rides Since 1923!



CUSTOM WIRE SETS APPLICATION GUIDE

To select wire color, replace X in part # with:

0 = Black **2 = Red** **6 = Blue**

Check Availability - Not all part numbers currently available in all colors.

Begin Year	End Year	Model	Engine	Street Thunder	High Energy Resistor Core	8mm Spiro Pro	White Ceramic Spiro Pro	Black Ceramic Spiro Pro	Thunder Volt 8.2	Black Ceramic 8.2mm	409 Pro Race	Plug Boot Angle	Coil Wire Length
CADILLAC (Continued)													
2002	2006	Escalade	5.3L (T), 6.0 (N)	53005	-	72X05	-	75005-B	82X05	85005-B	79X05	180	NR
2004	2005	CTS-V	5.7L LS6 (S)	51044	-	74X44	-	75044-B	84X44	85044-B	79X03	180	NR
1999	2000	Escalade	5.7L (R)	51036	-	74X36	-	-	84X36	-	-	90	17
1994	1996	Fleetwood	350, 5.7L (P)	-	-	74X27	-	-	84X27	-	79X04	90	11/12
1990	1993	Brougham, Fleetwood	350, 5.7L (7)	51011	64611	74X11	-	-	84X11	-	-	90/180	10
1991	1992	Brougham	305, 5.0L (E)	51011	64611	74X11	-	-	84X11	-	-	90/180	10
1987	1990	Brougham, Fleetwood (RWD), Deville	307, 5.0L (Y, 9)	51004	64604	74X04	-	-	84X04	-	79X32	135	12
1975	1980	All Models	350, 5.7L	51004	64604	74X04	-	-	84X04	-	79X32	135	12
1970	1973	All Models (non HEI)	472, 500	51014	64614	74X14	-	-	-	-	-	180/135	11
CHEVROLET													
6 Cylinder													
2006	2010	Impala, Malibu SS, Monte Carlo	3.9L (1, 3, M, N, R)	53048	-	-	-	-	82X48	-	-	OE	NR
2006	2010	Impala, Malibu, Monte Carlo	3.5L (K,N)	53048	-	-	-	-	82X48	-	-	OE	NR
2006	2009	Uplander	3.9L (1, W)	53048	-	-	-	-	82X48	-	-	OE	NR
2005	2009	Equinox	3.4L (9)	53047	-	-	-	-	82X47	-	-	OE	NR
2004	2006	Malibu	3.5L (8)	53047	-	-	-	-	82X47	-	-	OE	NR
2005	2006	Uplander	3.5L (L)	53047	-	-	-	-	82X47	-	-	OE	NR
2000	2005	Impala, Monte Carlo	3.4L (E)	53000	-	72X00	-	-	82X00	-	-	180	NR
1995	2005	Lumina, Monte Carlo, Malibu	3.1L (M), 3.4L (E)	53000	-	72X00	-	-	82X00	-	-	180	NR
2004	2005	Impala, Monte Carlo SS (Supercharged)	3.8L (1)	53006	-	72X06	-	-	-	-	-	180	NR
1998	2005	Impala, Lumina, Monte Carlo	3.8L (K)	53010	-	72X10	-	-	82X10	-	-	180	NR
1995	1999	Camaro	3.8L (K)	-	-	-	-	-	84X43	-	-	90	NR
1994	1996	Beretta, Corsica	3.1L (M)	53000	-	72X00	-	-	82X00	-	-	180	NR
1993	1993	Caprice	4.3L (Z)	51032	64632	74X32	-	-	84X32	-	-	90/180	12
1990	1992	Camaro	3.1L (T)	51000	-	74X00	-	-	84X00	-	-	180	16
1987	1989	Camaro	2.8L (S)	-	-	74X24	-	-	84X24	-	79X24	180	18
1983	1987	Malibu, Monte Carlo	3.8L (A)	51000	64600	74X00	-	-	84X00	-	-	180	16
1985	1986	Camaro, Celebrity, Citation (non Hi-Output)	2.8L (S,X)	51000	64600	74X00	-	-	84X00	-	-	180	16
1985	1986	Cavalier, Celebrity (Hi-Output)	2.8L (W)	-	-	74X24	-	-	84X24	-	79X24	180	18
1983	1985	Caprice	3.8L (A)	51000	64600	74X00	-	-	84X00	-	-	180	16
1984	1984	Citation	3.0L (L)	51000	64600	74X00	-	-	84X00	-	-	180	16
1983	1984	Camaro, Celebrity, Citation	2.8L (L, X, Z)	51000	64600	74X00	-	-	84X00	-	-	180	16
1983	1984	El Camino	3.8L (A)	51000	64600	74X00	-	-	84X00	-	-	180	16
1980	1982	All Models	2.8L (L)	51000	64600	74X00	-	-	84X00	-	-	180	16
1980	1981	All Models	3.8L (L)	51000	64600	74X00	-	-	84X00	-	-	180	16
1978	1979	El Camino, Malibu, Monte Carlo, Monza	196, 231	51000	64600	74X00	-	-	84X00	-	-	180	16
8 Cylinder													
2017	2017	Camaro ZL1 (Supercharged)	6.2L LT4	-	-	72X61	-	-	82X61	-	79X61	180	NR
2016	2017	Camaro SS	6.2L LT1	-	-	72X61	-	-	82X61	-	79X61	180	NR
2014	2015	Camaro Z28	7.0L LS7	53044	-	72X44	-	-	82X44	-	79X06	OE	NR
2012	2015	Camaro ZL1 (Supercharged)	6.2L LSA	51044	-	74X44	-	75044-B	84X44	85044-B	79X03	180	NR
2010	2015	Camaro SS	6.2L LS3-L99	51044	-	74X44	-	75044-B	84X44	85044-B	79X03	180	NR
2014	2015	SS	6.2L LS3	51044	-	74X44	-	75044-B	84X44	85044-B	79X03	180	NR
2006	2009	Impala SS, Monte Carlo SS	5.3L LS4 (C)	53044	-	72X44	-	-	82X44	-	79X06	180	NR
1998	2002	Camaro	5.7L LS-1	51044	-	74X44	-	75044-B	84X44	85044-B	79X03	180	NR
1996	1997	Camaro Z28	5.7L (P) LT1	51039	-	74X39	-	-	84X39	-	-	90	10/11
1994	1996	Caprice, Impala SS	5.7L (P) LT1	-	-	74X27	-	-	84X27	-	79X04	90	11/12
1993	1995	Camaro Z28	5.7L (P) LT1	51026	-	74X26	-	-	84X26	-	-	90	12
1993	1993	Caprice	5.0L (E), 5.7L (7)	51011	64611	74X11	-	-	84X11	-	-	90/180	10
1988	1992	Camaro, Caprice	5.0L, 5.7L	51011	64611	74X11	-	-	84X11	-	-	90/180	10
1987	1987	Camaro	5.0L (F, H)	51011	64611	74X11	-	-	84X11	-	-	90/180	10
1987	1987	Caprice	5.0L (Y)	51004	64604	74X04	-	-	84X04	-	79X32	135	12
1987	1987	Camaro	5.7L (8)	51009	64609	74X09	-	-	84X09	-	-	90/135	NR
1986	1986	Camaro, Caprice, El Camino, Monte Carlo	5.0L (G, H)	51007	64607	74X07	-	-	84X07	-	-	90/135	NR
1985	1985	Caprice, Impala	5.7L (6)	51007	64607	74X07	-	-	84X07	-	-	90/135	NR
1983	1985	Caprice, El Camino, Malibu, Monte Carlo	5.0L	51007	64607	74X07	-	-	84X07	-	-	90/135	NR
1983	1984	Camaro	5.0L	51007	64607	74X07	-	-	84X07	-	-	90/135	NR
1982	1982	Caprice, Impala	4.4L	51007	64607	74X07	-	-	84X07	-	-	90/135	NR
1982	1982	All Models (Except Camaro w/TBI)	5.0L	51007	64607	74X07	-	-	84X07	-	-	90/135	NR
1982	1982	El Camino, Malibu, Monte Carlo	5.0L	51007	64607	74X07	-	-	84X07	-	-	90/135	NR
1981	1981	El Camino, Malibu, Monte Carlo	4.4L	51016	64616	74X16	-	-	84X16	-	-	180/135	NR
1981	1981	All Models (Except Camaro)	4.4L, 5.0L, 5.7L	51007	64607	74X07	-	-	84X07	-	-	90/135	NR
1980	1980	Camaro (Except California)	4.4L, 5.0L, 5.7L	51002	64602	74X02	-	75028-B	84X02	-	79X28	90	10
1980	1980	Caprice, El Camino, Malibu, Monte Carlo	4.4L, 5.0L	51007	64607	74X07	-	-	84X07	-	-	90/135	NR
1979	1979	El Camino, Malibu, Monte Carlo	267, 305, 350	51007	64607	74X07	-	-	84X07	-	-	90/135	NR
1979	1979	Camaro, Caprice, Impala, Nova	305, 350	51002	64602	74X02	-	75028-B	84X02	-	79X28	90	10
1978	1978	Camaro, Caprice, Nova	305	51002	64602	74X02	-	75028-B	84X02	-	79X28	90	10
1978	1978	El Camino, Malibu, Monte Carlo	305	51007	64607	74X07	-	-	84X07	-	-	90/135	NR
1974	1977	All Models (w/HEI)	305, 350, 400	51002	64602	74X02	-	75028-B	84X02	-	79X28	90	10
1974	1976	All Models (w/HEI)	454	51004	64604	74X04	-	-	84X04	-	79X32	135	12
1970	1974	All Models (non HEI)	400	51001	64601	74X01	-	-	84X01	-	79X27	90	11
1970	1974	All Models (non HEI)	454	51003	64603	74X03	-	-	84X03	-	79X31	135	18
1967	1974	All Models (non HEI)	350	51001	64601	74X01	-	-	84X01	-	79X27	90	11
1970	1972	All Models	402	51003	64603	74X03	-	-	84X03	-	79X31	135	18
1968	1972	All Models	307	51001	64601	74X01	-	-	84X01	-	79X27	90	11
1965	1970	All Models	396, 427	51003	64603	74X03	-	-	84X03	-	79X31	135	18
1968	1969	All Models	302	51001	64601	74X01	-	-	84X01	-	79X27	90	11
1964	1969	All (Except 67-64 Chevy II, Nova)	283	51001	64601	74X01	-	-	84X01	-	79X27	90	11
1964	1969	All (Except 67-64 Chevy II, Nova)	327	51001	64601	74X01	-	-	84X01	-	79X27	90	11
1964	1967	Chevy II, Nova	283, 327	51005	64605	74X05	-	-	84X05	-	79X29	90	10
1961	1967	All Models	283	51001	64601	74X01	-	-	84X01	-	79X27	90	11
1958	1965	All Models	348, 409	51005	64605	74X05	-	-	84X05	-	79X65	90	10



Firing America's Finest Rides Since 1923!



CUSTOM WIRE SETS APPLICATION GUIDE

To select wire color, replace X in part # with:

0 = Black **2 = Red** **6 = Blue**

Check Availability - Not all part numbers currently available in all colors.

Begin Year	End Year	Model	Engine	Street Thunder	High Energy Resistor Core	8mm Spiro Pro	White Ceramic Spiro Pro	Black Ceramic Spiro Pro	Thunder Volt 8.2	Black Ceramic 8.2mm	409 Pro Race	Plug Boot Angle	Coil Wire Length
CORVETTE													
2014	2017	C7 Stingray	6.2L LT1	-	-	72X61	-	-	82X61	-	79X61	180	NR
2015	2017	C7 Stingray Z06 (Supercharged)	6.2L LT4	-	-	72X61	-	-	82X61	-	79X61	180	NR
2006	2013	C6 Z06	7.0L LS7 (E)	53044	-	72X44	-	-	82X44	-	79X06	OE	NR
2008	2013	C6 Coupe, Convertible	6.2L LS3 (W)	53044	-	72X44	-	-	82X44	-	79X06	OE	NR
2009	2013	C6 ZR1 (Supercharged)	6.2L LS9 (W)	51044	-	74X44	-	75044-B	84X44	85044-B	79X03	180	NR
2005	2007	C6 Coupe, Convertible	6.0L LS2 (U, H)	53044	-	72X44	-	-	82X44	-	79X06	OE	NR
1997	2004	C5 Coupe, Convertible, Z06 (LS-1/LS-6)	5.7L (G), 5.7L (S)	51044	-	74X44	-	75044-B	84X44	85044-B	79X03	180	NR
1992	1996	C4 LT-1, LT-4	5.7L (P)	51025	-	74X25	-	-	84X25	-	79X33	90/180	15/16
1985	1991	C4	5.7L (8) L98	51009	64609	74X09	-	-	84X09	-	-	90/135	NR
1975	1982	C3	350	51017	64617	74X17	-	-	84X17	-	-	90	NR
1974	1974	C3 All (w/HEI)	350	51002	64602	74X02	-	75028-B	84X02	-	79X28	90	10
1974	1974	C3 All (w/HEI)	454	51004	64604	74X04	-	-	84X04	-	79X32	135	12
1971	1974	C3 All (non HEI)	350, 400	51005	64605	74X05	-	-	84X05	-	79X29	90	10
1965	1974	C2 / C3 All (non HEI)	396, 427, 454	51003	64605	74X03	-	-	84X03	-	79X31	135	18
1960	1970	C2 / C3 All	283, 327, 350	51005	64605	74X05	-	-	84X05	-	79X29	90	10

GM TRUCKS													
4 Cylinder													
1998	2003	S10, S15	2.2L	53012	-	-	-	-	82X12	-	-	180	NR
6 Cylinder													
2007	2014	Express / Savana	4.3L	-	-	72X96	-	-	-	-	-	180	NR
2007	2013	Silverado/Sierra 1500	4.3L	-	-	72X96	-	-	-	-	-	180	NR
1996	2006	All w/Horizontal Distributor Cap	4.3L (W, Z) Vortec	51035	-	74X35	-	-	84X35	-	-	90/180	12/16
1996	2006	Lumina APV, Venture APV, Montana	3.4L (E)	53000	-	72X00	-	-	82X00	-	-	180	NR
1996	1996	G Series Vans (HEI)	4.3L (Z) Vortec	51032	64632	74X32	-	-	84X32	-	-	90/180	12
1994	1995	C, K, G, Lm, P, S, Blazer, Jimmy (HEI)	4.3L (W, Z) Vortec	51032	64632	74X32	-	-	84X32	-	-	90/180	12
1988	1993	C, K, G, L, M Van, P, S, T	4.3L (B, W, Z)	51032	64632	74X32	-	-	84X32	-	-	90/180	12
1982	1993	S, T Series (S10, S15)	2.8L	51000	64600	74X00	-	-	84X00	-	-	180	16
1987	1987	G, L, M Van, R, V, Pick-Up Trucks	4.3L (Z)	51032	64632	74X32	-	-	84X32	-	-	90/180	12
1986	1986	L, M Van	4.3L	51032	64632	74X32	-	-	84X32	-	-	90/180	12
1977	1984	Caballero, El Camino	231, 3.8L (A)	51000	64600	74X00	-	-	84X00	-	-	180	16
1981	1981	G, P	231, 3.8L	51000	64600	74X00	-	-	84X00	-	-	180	16
8 Cylinder													
2014	2017	Silverado/Sierra 1500	5.3L L83 EcoTec3	-	-	72X61	-	-	82X61	-	79X61	180	NR
2014	2017	Silverado/Sierra 1500	6.2L L86 EcoTec3	-	-	72X61	-	-	82X61	-	79X61	180	NR
2014	2017	Silverado/Sierra 2500/3500, Tahoe/Yukon, Suburban	6.0L LY6 Vortec	51044	-	74X44	-	75044-B	84X44	85044-B	79X03	180	NR
2014	2014	Avalanche, Tahoe/Yukon, Suburban 1500, Express G1500	5.3L (J, 0, 3, M)	51044	-	74X44	-	75044-B	84X44	85044-B	79X03	180	NR
2014	2014	Tahoe, Yukon	6.2L (2, 8)	51044	-	74X44	-	75044-B	84X44	85044-B	79X03	180	NR
2009	2013	Silverado/Seirra 1500, Tahoe/Yukon, Express G2500/3500	4.8L (C)	51044	-	74X44	-	75044-B	84X44	85044-B	79X03	180	NR
2009	2013	Silverado/Sierra 1500, Avalanche, Tahoe/Yukon, Suburban 1500, Express G1500	5.3L (J, 0, 3, M)	51044	-	74X44	-	75044-B	84X44	85044-B	79X03	180	NR
2009	2013	Silverado/Sierra 1500/2500, Avalanche, Tahoe/Yukon Suburban 1500 & 2500, Express G2500 & 3500	6.0L (Y, 5, K, H)	51044	-	74X44	-	75044-B	84X44	85044-B	79X03	180	NR
2009	2012	Silverado/Sierra 1500, Sierra Denali Tahoe/Yukon Canyon, Colorado	6.2L (2, 8)	51044	-	74X44	-	75044-B	84X44	85044-B	79X03	180	NR
2005	2009	Traillblazer, Traillblazer SS	5.3L (M), 6.0L (H)	53044	-	72X44	-	-	82X44	-	79X06	OE	NR
2008	2009	Kodiak, Topkick C2500, 3500, 4500, 5500, 6500, 7500	8.1L (E & G)	-	-	72X25	-	-	82X25	-	79X86	OE	NR
2007	2008	Silverado/Seirra 1500, Tahoe/Yukon, G2500	4.8L (C)	53044	-	72X44	-	-	82X44	-	79X06	OE	NR
2007	2008	Avalanche, Tahoe/Yukon, Silverado/ Sierra 1500, Suburban 1500, G1500	5.3L (J, 0, 3)	53044	-	72X44	-	-	82X44	-	79X06	OE	NR
2005	2008	Envoy, Envoy Denali	5.3L (M)	53044	-	72X44	-	-	82X44	-	79X06	OE	NR
2007	2008	Silverado & Sierra 1500 & 2500, Avalanche, Tahoe/Yukon, Suburban 1500 & 2500, Express G2500 & G3500	6.0L (Y, K, H, 5)	53044	-	72X44	-	-	82X44	-	79X06	OE	NR
2007	2008	Sierra Denali, Yukon Denali	6.2L (8)	53044	-	72X44	-	-	82X44	-	79X06	OE	NR
2001	2007	C, K, G, P 2500, 3500, 4500, 5500, 6500, 7500	8.1L (E & G)	-	-	72X25	-	-	82X25	-	79X86	OE	NR
2005	2006	SSR	6.0L (H)	53044	-	72X44	-	-	82X44	-	79X06	OE	NR
1999	2006	Vortec LS1, LR4, LM7, LQ4 Round Coil #19005218 (Delphi)	4.8L, 5.3L, 6.0L	51044	-	74X44	-	75044-B	84X44	85044-B	79X03	180	NR
		Vortec LS1, LR4, LM7, LQ4 (Except W, T Series) Square Coil		53005	-	72X05	-	75005-B	82X05	85005-B	79X05	180	NR
1999	2006	#12558693 (Mitsubishi)	4.8L, 5.3L, 6.0L	-	-	-	-	-	-	-	-	-	-
2003	2004	SSR	5.3L	53005	-	72X05	-	75005-B	82X05	85005-B	79X05	180	NR
2003	2004	SSR	5.3L	53005	-	72X05	-	75005-B	82X05	85005-B	79X05	180	NR
1996	2002	Vortec L30 (Horizontal Cap)	5.0L (M), 5.7L (C)	51036	-	74X36	-	-	84X36	-	-	90	17
1996	2002	Full Size C,K; 1 Ton Chassis, 1/2 3/4, 1 Ton Vans	5.0L (M), 5.7L (R)	51036	-	74X36	-	-	84X36	-	-	90	17
		Vortec L29 (Horizontal Cap) Full Size C,K; 1 Ton Chassis, 1		-	-	74X37	-	-	84X37	-	-	180	12
1996	2000	Ton Vans	7.4L (J)	-	-	-	-	-	-	-	-	-	-
1994	1997	G, P Series Vans	7.4L (N)	51029	64629	74X29	75X24	-	84X29	-	-	180	10
1994	1996	G, P Series Vans	5.0L (H), 5.7L (K)	-	-	-	-	-	-	-	-	90	10
1994	1995	C, K Pickup Only	5.0L (H), 5.7L (K)	51028	64628	74X28	-	-	84X28	-	79X81	90	10
1990	1995	C, K, G, P	7.4L (N)	51029	64629	74X29	75X24	-	84X29	-	-	180	10
1988	1993	C, K, G	5.0L (H)	51028	64628	74X28	-	-	84X28	-	79X81	90	10
1988	1993	C, K, G, P	5.7L (K)	51028	64628	74X28	-	-	84X28	-	79X81	90	10
1988	1991	R V	5.7L (K)	51028	64628	74X28	-	-	84X28	-	79X81	90	10
1990	1991	R V	7.4L (N)	51029	64629	74X29	75X24	-	84X29	-	-	180	10
1989	1989	P Series	5.7L (M)	51017	64617	74X17	-	-	84X17	-	-	90	NR
1988	1989	C, K, G, R, V	7.4L (N)	51029	64629	74X29	75X24	-	84X29	-	-	180	10
1988	1988	C, K, P, R, V (w/Carb)	5.7L (M)	51002	64602	74X02	-	75028-B	84X02	-	79X28	90	10
1987	1987	G, P, R, V Pickup Trucks, Suburban (w/TBI)	5.0L (H), 5.7L (K)	51028	64628	74X28	-	-	84X28	-	79X81	90	10
1987	1987	G, P, R, V Pickup Trucks, Suburban(w/Carb)	5.7L (M)	51002	64602	74X02	-	75028-B	84X02	-	79X28	90	10
1987	1987	R, V Pickup Trucks, Suburban (w/TBI)	7.4L (N)	51029	64629	74X29	75X24	-	84X29	-	-	180	10



Firing America's Finest Rides Since 1923!



CUSTOM WIRE SETS APPLICATION GUIDE

To select wire color, replace X in part # with:

0 = Black

2 = Red

6 = Blue

Check Availability - Not all part numbers currently available in all colors.

Begin Year	End Year	Model	Engine	Street Thunder	High Energy Resistor Core	8mm Spiro Pro	White Ceramic Spiro Pro	Black Ceramic Spiro Pro	Thunder Volt 8.2	Black Ceramic 8.2mm	409 Pro Race	Plug Boot Angle	Coil Wire Length
GM TRUCKS (Continued)													
1984	1986	G Series Vans	305, 5.0L	51002	64602	74X02	-	75028-B	84X02	-	79X28	90	10
1983	1986	C, K, Pickups, Caballero, El Camino	305, 5.0L	51007	64607	74X07	-	-	84X07	-	-	90/135	NR
1983	1986	G, P	305, 5.0L	51002	64602	74X02	-	75028-B	84X02	-	79X28	90	10
1983	1986	C, K, P Series	366, 427, 454 7.4L	51063	64663	74X63	-	-	84X63	-	79X67	135	11
1984	1984	50 Series	350, 5.7L	51017	64617	74X17	-	-	84X17	-	-	90	NR
1982	1983	C, K	454, 7.4L	51063	64663	74X63	-	-	84X63	-	79X67	135	11
1982	1982	Caballero, El Camino	267, 4.4L	51007	64607	74X07	-	-	84X07	-	-	90/135	NR
1982	1982	P, 50 Series	366, 427, 454	51063	64663	74X63	-	-	84X63	-	79X67	135	11
1981	1982	50 Series	305, 350	51017	64617	74X17	-	-	84X17	-	-	90	NR
1981	1982	C, K 10-20, Caballero, El Camino	305, 5.0L	51007	64607	74X07	-	-	84X07	-	-	90/135	NR
1981	1982	C, K 30-35, G Series, P Series	305, 5.0L	51002	64602	74X02	-	75028-B	84X02	-	79X28	90	10
1981	1982	C, K 10-20	350, 5.7L	51007	64607	74X07	-	-	84X07	-	-	90/135	NR
1981	1982	C, K 30-35, G Series, P Series	350, 5.7L	51002	64602	74X02	-	75028-B	84X02	-	79X28	90	10
1981	1981	Caballero, El Camino	265, 4.3L	51016	64616	74X16	-	-	84X16	-	-	180/135	NR
1981	1981	50-60 Series	350, 5.7L	51017	64617	74X17	-	-	84X17	-	-	90	NR
1981	1981	G, P Series	366, 400, 403, 452, 454	51063	64663	74X63	-	-	84X63	-	79X67	135	11
1980	1980	Caballero, El Camino	267, 305	51007	64607	74X07	-	-	84X07	-	-	90/135	NR
1980	1980	C, K, G	305, 5.0L	51002	64602	74X02	-	75028-B	84X02	-	79X28	90	10
1980	1980	C, K, G, P	350, 5.7L	51002	64602	74X02	-	75028-B	84X02	-	79X28	90	10
1980	1980	50-60 Series	350, 5.7L	51017	64617	74X17	-	-	84X17	-	-	90	NR
1977	1979	Caballero, El Camino	267, 305	51007	64607	74X07	-	-	84X07	-	-	90/180	NR
1977	1979	C, K, G, P	305, 350, 400	51002	64602	74X02	-	75028-B	84X02	-	79X28	90	10
1977	1979	50-60 Series	350	51017	64617	74X17	-	-	84X17	-	-	90	NR
1977	1979	C, K, G, P	366, 427, 454	51063	64663	74X63	-	-	84X63	-	79X67	135	11
1975	1976	C, K, G, P	305, 350, 400	51002	64602	74X02	-	75028-B	84X02	-	79X28	90	10
1975	1976	G Series Vans	366, 427	51063	64663	74X63	-	-	84X63	-	79X67	135	11
1975	1976	C, K, G, P	454, 7.4L	51004	64604	74X04	-	-	84X04	-	79X32	135	12
1966	1975	All (non HEI)	396, 400, 402	51003	64603	74X03	-	-	84X03	-	79X31	135	18
1966	1975	All (non HEI)	454	51003	64603	74X03	-	-	84X03	-	79X31	135	18
1973	1974	All (non HEI)	307, 350, 400	51001	64601	74X01	-	-	84X01	-	79X27	90	11
1970	1972	G Series, El Camino	307, 350	51001	64601	74X01	-	-	84X01	-	79X27	90	11
1965	1972	All (Except G Series & El Camino)	283, 307, 350	51005	64605	74X05	-	-	84X05	-	79X29	90	10
1961	1965	All	348, 409	51052	64652	74X52	-	-	84X52	-	79X65	180	14/15
1955	1965	All	283, 327	51005	64605	74X05	-	-	84X05	-	79X29	90	10

DODGE / CHRYSLER

4 Cylinder													
2003	2009	PT Cruiser Turbo (GT Cruiser) (G, 8)	2.4L DOHC	-	-	-	-	-	87X35	-	-	OE	NR
2003	2005	Neon SRT-4 (S)	2.4L DOHC	-	-	-	-	-	87X35	-	-	OE	NR
1995	2002	Avenger, Cirrus, Sebring, Stratus, Talon	2.0L, 2.4L DOHC	-	-	-	-	-	87X35	-	-	OE	NR
1995	2000	Neon (150Hp)	2.0L DOHC	-	-	-	-	-	87X35	-	-	OE	NR
1987	1995	All	2.5L	-	-	74X70	-	-	-	-	-	180	14/29
1981	1994	All (Except 91-93 Daytona IROC R/T, Spirit R/T)	2.2L	-	-	74X70	-	-	-	-	-	180	14/29
1984	1989	Conquest	2.6L	-	-	-	-	-	87X30	-	-	180	19/28
6 Cylinder													
1991	1996	Stealth	3.0L SOHC	-	-	-	-	-	87X34	-	-	OE	NR
8 Cylinder													
2005	2005	300C, Magnum R/T w/MDS (OE Replacement Wires)	5.7L HEMI	-	-	72X34	-	-	-	-	-	OE	NR
2005	2005	300C, Magnum R/T w/MDS (Shorty Conversion Wires)	5.7L HEMI	-	-	72X41	-	-	82X41	-	79X10	OE	NR
1981	1990	All	318, 5.2L	51071	64671	74X71	-	-	84X71	-	-	180	14/25
1978	1980	All	318, 360	51071	64671	74X71	-	-	84X71	-	-	180	14/25
1963	1979	All (Except Hemi)	383, 400, 426, 440	51072	64672	74X72	-	-	84X72	-	79X78	90/135	12
1963	1979	All w/HEI (Except Hemi)	383, 400, 426, 440	-	-	-	-	-	-	-	79X87	90/135	12
1963	1978	All	273, 318, 340, 360	51071	64671	74X71	-	-	84X71	-	-	180	14/25
1960	1964	All (w/Ram-Air Induction)	413	51072	64672	74X72	-	-	84X72	-	79X78	90/135	12
1955	1959	All	318, 360, 383	51003	64603	74X03	-	-	84X03	-	79X31	135	18
10 Cylinder													
2003	2006	Viper SRT-10	8.3L	-	-	72X45	-	-	82X45	-	-	180	NR
1992	1996	Viper RT-10 Roadster	488, 8.0L	-	-	-	-	-	84X77	-	-	OE	NR

DODGE TRUCKS

4 Cylinder													
1996	2000	Caravan, Voyager	2.4L DOHC	-	-	-	-	-	87X35	-	-	OE	NR
1984	1995	Dakota, Rampage, Mini Van	2.2L, 2.5L SOHC	-	-	74X70	-	-	-	-	-	180	14/29
1987	1989	Raider, Ram, Ram 50	2.0L, 2.6L	-	-	-	-	-	87X30	-	-	180	19/28
6 Cylinder													
2001	2010	Grand Caravan, Town & Country	3.3, 3.8L	-	-	-	-	-	82X43	-	-	180	-
2005	2008	Pacifica	3.8L	-	-	-	-	-	82X43	-	-	180	-
2001	2003	Voyager	3.3L	-	-	-	-	-	82X43	-	-	180	-
1992	2003	Dakota, Ram	239, 3.9 L	51075	64675	-	-	-	84X75	-	-	180	32
1987	1991	Dakota, Ram	239, 3.9 (M,X)	-	64674	-	-	-	-	-	-	180	15
8 Cylinder													
2003	2005	Ram 1500, 2500, 3500, Durango (OE Repl. Wires)	5.7L HEMI	-	-	-	-	-	82X26	-	-	OE	NR
2003	2005	Ram 1500, 2500, 3500, Durango (Shorty Conv. Wires)	5.7L HEMI	-	-	72X41	-	-	82X41	-	79X10	OE	NR
1993	2003	Dakota, Durango, Ram, Vans	360, 5.9L	51076	64676	74X76	-	-	84X76	-	79X82	180	33/37
1992	2002	Dakota, Durango, Ram (w/Multi Point Injection)	318, 5.2L	51076	64676	74X76	-	-	84X76	-	79X82	180	33/37
1992	1992	All (w/o Multi Point Injection)	318, 360	51071	64671	74X71	-	-	84X71	-	-	180	14/25
1964	1979	All	383, 400, 413, 440	51072	64672	74X72	-	-	84X72	-	79X78	90/135	12
1960	1976	All	273	51071	64671	74X71	-	-	84X71	-	-	180	14/25
1960	1991	All	318, 360	51071	64671	74X71	-	-	84X71	-	-	180	14/25
10 Cylinder													
2004	2006	Ram SRT-10	8.3L Viper	-	-	72X45	-	-	82X45	-	-	180	NR
1994	2003	Ram 2500, 3500	8.0L Magnum	-	-	-	-	-	84X73	-	-	OE	NR



Firing America's Finest Rides Since 1923!



CUSTOM WIRE SETS APPLICATION GUIDE

To select wire color, replace X in part # with:

0 = Black **2 = Red** **6 = Blue**

Check Availability - Not all part numbers currently available in all colors.

Begin Year	End Year	Model	Engine	Street Thunder	High Energy Resistor Core	8mm Spiro Pro	White Ceramic Spiro Pro	Black Ceramic Spiro Pro	Thunder Volt 8.2	Black Ceramic 8.2mm	409 Pro Race	Plug Boot Angle	Coil Wire Length
EAGLE													
1995	1998	Talon ESi, (Non Turbo)	2.0L DOHC 420A	-	-	-	-	-	87X35	-	-	OE	NR
FORD / LINCOLN / MERCURY													
4 Cylinder													
2011	2017	Fiesta S / SE / SES / SEL / Titanium / ST	1.6L DOHC N/A & Turbo	-	-	-	-	-	82X49	-	-	OE	NR
2000	2004	Focus SE, ZX3, ZX5, ZTS, SVT (Zetec)	2.0L DOHC (3)	53009	-	-	-	-	82X09	-	-	OE	NR
1999	2002	Contour, Mystique (Late) After 5/03/99	2.0L DOHC (3)	53009	-	-	-	-	82X09	-	-	OE	NR
1991	1993	Mustang (Twin Plug)	2.3L (M)	-	-	-	-	-	84X87	-	-	180	NR
1977	1988	All Models (Including Turbo)	140, 2.3L	-	64667	74X67	-	-	84X67	-	-	180	16/25
6 Cylinder													
2005	2010	Mustang	4.0L (N)	53037	-	72X37	-	-	82X37	-	-	OE	NR
2001	2004	Mustang	3.8L (4)	53036	-	-	-	-	82X36	-	-	135	NR
1995	2000	Contour, Contour SVT, Mystique, Cougar	2.5L	-	-	-	-	-	82X07	-	-	90	NR
1989	1995	Thunderbird, Cougar (Supercharged)	3.8L (R)	-	-	-	-	-	84X69	-	-	135	NR
1988	1990	Mercur Scorpio	2.9L (V)	-	64664	-	-	-	84X64	-	-	135	31/31
8 Cylinder													
1996	1998	Crown Vic, Marquis, Town Car	4.6L SOHC	51089	-	-	-	-	-	-	79X80	OE	NR
1996	1998	Mustang GT (16 Valve)	4.6L SOHC (X)	-	-	-	-	-	84X84	-	79X57	OE	NR
1994	1998	Thunderbird, Cougar	4.6L SOHC	-	-	-	-	-	84X85	-	-	OE	NR
1994	1995	Mustang, Mustang SVT Cobra	5.0L	-	-	74X92	-	-	84X92	-	-	135	8
1989	1993	Mustang	5.0L	51058	64658	74X58	-	-	84X58	-	79X58	135	8/24
1989	1992	Mark VII LSC	5.0L	51058	64658	74X58	-	-	84X58	-	79X58	135	8/24
1989	1990	Ford, Mercury	5.8L	51055	64655	74X55	-	-	84X55	-	-	135	11/13/22
1987	1988	Mustang, Mark VII Comtech, LSC	302, 5.0L	-	64657	74X57	-	-	-	-	79X58	135	11/24
1986	1988	Continetal, Mark VII LSC (Exc. Comtech)	302, 5.0L	51058	64658	74X58	-	-	84X58	-	79X58	135	8/24
1986	1988	Ford, Mercury	351W, 5.8L	-	64657	74X57	-	-	-	-	79X58	135	11/24
1984	1988	Thunderbird, Cougar	302, 5.0L	51058	64658	74X58	-	-	84X58	-	79X58	135	8/24
1984	1988	Ford, Mercury (w/EEC IV)	302, 5.0L	51058	64658	74X58	-	-	84X58	-	79X58	135	8/24
1986	1986	Mustang, Capri	302, 5.0L	-	64657	74X57	-	-	-	-	79X58	135	11/24
1984	1985	Mustang, Ford/ Merc. (w/Dura-Spark)	302, 5.0L	51055	64655	74X55	-	-	84X55	-	-	135	11/13/22
1984	1985	Mustang, Capri, LTD, Marquis (w/EEC IV)	302, 5.0L	-	64657	74X57	-	-	-	-	79X58	135	11/24
1984	1985	Lincoln	302, 5.0L	51058	64658	74X58	-	-	84X58	-	79X58	135	8/24
1980	1985	Ford, Mercury, Lincoln	351W, 5.8L	51055	64655	74X55	-	-	84X55	-	-	135	11/13/22
1983	1983	All Models	302, 5.0L	51055	64655	74X55	-	-	84X55	-	-	135	11/13/22
1980	1982	Mustang	255, 4.2L	51055	64655	74X55	-	-	84X55	-	-	135	11/13/22
1977	1982	Mustang, Capri, Thunderbird	302, 5.0L	51055	64655	74X55	-	-	84X55	-	-	135	11/13/22
1979	1979	Thunderbird	351W	-	64657	74X57	-	-	-	-	79X58	135	11/24
1977	1979	Ford, Mercury	351M, 400	51063	64663	74X63	-	-	84X63	-	79X67	135	11
1977	1978	Thunderbird	351W	51055	64655	74X55	-	-	84X55	-	-	135	11/13/22
1977	1978	Ford	460	51055	64655	74X55	-	-	84X55	-	-	135	11/13/22
1975	1976	All Models	302, 351W, 460	51062	64662	74X62	-	-	84X62	-	-	135	14
1975	1976	All Models	351M, 400	51051	64651	74X51	-	-	84X51	-	79X79	180	14/14
1973	1974	All Models	302, 351C, 400, 429, 460	51061	64661	74X61	-	-	84X61	-	-	180	15
1971	1974	De Tomaso Pantera	351C	51061	64661	74X61	-	-	84X61	-	-	180	15
1970	1974	All Models	351W	51062	64662	74X62	-	-	84X62	-	-	135	14
1970	1972	All (Except Boss)	302	51059	64659	74X59	-	-	84X59	-	-	135	14
1970	1972	Boss	302	51061	64661	74X61	-	-	84X61	-	-	180	15
1970	1972	All Models (Except Boss 429)	351C, 351W, 352, 390, 400, 427, 428, 429, 460	51061	64661	74X61	-	-	84X61	-	-	180	15
1970	1970	Boss	351C, 428	51061	64661	74X61	-	-	84X61	-	-	180	15
1970	1970	All Models	390	51052	64652	74X52	-	-	84X52	-	79X65	180	14/15
1970	1970	All Models	429, 460	51062	64662	74X62	-	-	84X62	-	-	135	14
1958	1969	All Models (w/DSI)	429, 460	-	-	-	-	-	-	-	79X66	135	24
1958	1969	All (Except 292)	ALL	51052	64652	74X52	-	-	84X52	-	79X65	180	14/15
FORD TRUCKS													
4 Cylinder													
2000	2004	Escape	2.0L	53009	-	-	-	-	82X09	-	-	OE	NR
1995	2001	Ranger (w/Dual Plugs)	2.3L, 2.5L	-	-	-	-	-	82X18	-	-	OE	NR
1989	1994	Ranger (w/Dual Plugs)	140, 2.3L (A)	-	-	-	-	-	84X87	-	-	180	NR
1983	1989	Ranger, Bronco II (w/Single Plugs)	2.0L, 2.3L	-	64667	74X67	-	-	84X67	-	-	180	16/25
6 Cylinder													
2001	2011	Ranger	4.0L SOHC	-	-	-	-	-	82X32	-	-	OE	NR
2001	2008	F Series Truck, E Series Van	4.2L	53040	-	-	-	-	-	-	-	135	NR
2001	2005	Explorer Sport Trac	4.0L SOHC	-	-	-	-	-	82X32	-	-	OE	NR
2001	2003	Explorer Sport	4.0L SOHC	-	-	-	-	-	82X32	-	-	OE	NR
1997	2000	Explorer, Ranger	4.0L OHV (X)	-	-	-	-	-	82X03	-	-	135	NR
1997	2000	E, F Series	4.2L (2)	-	-	-	-	-	84X96	-	-	135	NR
1996	2000	Aerostar, Ranger	3.0L	-	-	-	-	-	84X98	-	-	135	NR
1991	1996	Aerostar, Explorer, Ranger	244, 4.0L	-	-	-	-	-	84X83	-	-	135	NR
1977	1996	E, F Series	300, 4.9L	-	64666	74X66	-	-	84X66	-	-	180/135	14/12
1991	1995	Aerostar, Ranger	183, 3.0L	-	-	-	-	-	-	-	-	135	NR
1990	1992	Ranger	177, 2.9L	-	64664	-	-	-	84X64	-	-	135	31/31
1986	1990	Aerostar	183, 3.0L	-	-	-	-	-	-	-	-	135	11
1983	1989	Ranger, Bronco II	177, 2.9L	-	64664	-	-	-	84X64	-	-	135	31/31
8 Cylinder													
2011	2014	F-250, F-350	6.2L	-	-	72X94	-	-	82X94	-	-	180	NR
2010	2014	F-150 Raptor	6.2L	-	-	72X94	-	-	82X94	-	-	180	NR
1998	2001	Explorer, Mountaineer	5.0L	-	-	-	-	-	82X23	-	-	OE	NR
1997	1998	E, F Series, Expedition	4.6L	51089	-	-	-	-	-	-	79X80	OE	NR
1996	1998	E, F Series	7.5L	-	-	-	-	-	84X99	-	-	135	18
1986	1998	Bronco, E, F Series	5.8L	51058	64658	74X58	-	-	84X58	-	79X58	135	8/24
1985	1996	Bronco, E, F Series	5.0L	51058	64658	74X58	-	-	84X58	-	79X58	135	8/24



Firing America's Finest Rides Since 1923!

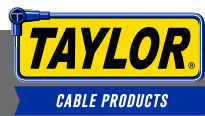

CUSTOM WIRE SETS APPLICATION GUIDE

To select wire color, replace X in part # with:

0 = Black

2 = Red

6 = Blue

Check Availability - Not all part numbers currently available in all colors.

Begin Year	End Year	Model	Engine	Street Thunder	High Energy Resistor Core	8mm Spiro Pro	White Ceramic Spiro Pro	Black Ceramic Spiro Pro	Thunder Volt 8.2	Black Ceramic 8.2mm	409 Pro Race	Plug Boot Angle	Coil Wire Length
FORD TRUCKS (Continued)													
1989	1995	E, F Series	7.5L	51055	64655	74X55	-	-	84X55	-	-	135	11/13/22
1984	1988	E, F Series	370, 429, 460	51055	64655	74X55	-	-	84X55	-	-	135	11/13/22
1984	1985	E, F Series (w/EEC IV)	5.8L	-	64657	74X57	-	-	-	-	79X58	135	11/24
1984	1984	Bronco, E, F Series	5.0L	51055	64655	74X55	-	-	84X55	-	-	135	11/13/22
1983	1984	Bronco (w/Dura-Spark Ign)	5.8L	51055	64655	74X55	-	-	84X55	-	-	135	11/13/22
1982	1983	E, F Series	400, 6.6L	51063	64663	74X63	-	-	84X63	-	79X67	135	11
1980	1983	All Models	255, 302	51055	64655	74X55	-	-	84X55	-	-	135	11/13/22
1980	1983	All Models	351, 370, 429	51055	64655	74X55	-	-	84X55	-	-	135	11/13/22
1979	1981	Super Duty	401, 477, 534	51051	64651	74X51	-	-	84X51	-	79X79	180	14/14
1977	1979	All Models	255, 302, 351W	51055	64655	74X55	-	-	84X55	-	-	135	11/13/22
1977	1979	All Models	351M, 400	51063	64663	74X63	-	-	84X63	-	79X67	135	11
1977	1979	All Models	460, 7.5L	51055	64655	74X55	-	-	84X55	-	-	135	11/13/22
1977	1978	FT Engine	330, 475	51051	64651	74X51	-	-	84X51	-	79X79	180	14/14
1977	1978	385 Series (B/F 600/800)	370, 429	51063	64663	74X63	-	-	84X63	-	79X67	135	11
1965	1976	FE Engine (E, F Series)	332, 352, 390, 427, 428	51051	64651	74X51	-	-	84X51	-	79X79	180	14/14
1965	1976	All Models	302, 351M, 351W, 360, 428, 429, 460	51052	64652	74X52	-	-	84X52	-	79X65	180	14/15
HUMMER													
8 Cylinder													
2008	2009	H2, H3, H3T	5.3L (L) 6.2L (8)	53044	-	72X44	-	-	82X44	-	79X06	OE	NR
2003	2007	H2	6.0L (U)	53005	-	72X05	-	75005-B	82X05	85005-B	79X05	180	NR
1995	1996	H1	5.7L	51028	64628	74X28	-	-	84X28	-	79X81	90	10
HYUNDAI													
4 Cylinder													
1990	1998	Sonata	3.0L	-	-	-	-	-	87X34	-	-	OE	NR
ISUZU													
4 Cylinder													
1983	1987	Impulse (w/o Turbo)	2.0L	-	-	-	-	-	87X30	-	-	180	19/28
6 Cylinder													
1996	2002	Hombre (w/Horizontal Dist. Cap)	4.3L Vortec	51035	-	74X35	-	-	84X35	-	-	90/180	12/16
1993	1995	NPR & W Series Trucks	5.7L	51028	64628	74X28	-	-	84X28	-	79X81	90	10
1991	1994	Pickup	3.1L	51000	64600	74X00	-	-	84X00	-	-	180	16
1991	1992	Rodeo	3.1L	51000	64600	74X00	-	-	84X00	-	-	180	16
1989	1991	Trooper II	2.8L	51000	64600	74X00	-	-	84X00	-	-	180	16
8 Cylinder													
2005	2006	Ascender	5.3L	53044	-	72X44	-	-	82X44	-	79X06	OE	NR
2003	2005	Ascender, I-370, N	5.3L, 6.0L	53005	-	72X05	-	75005-B	82X05	85005-B	79X05	180	NR
1996	2002	N, Medium Trucks	5.7L	51036	-	74X36	-	-	84X36	-	-	90	17
1993	1995	NPR & W Series Trucks	5.7L	51028	64628	74X28	-	-	84X28	-	79X81	90	10
JEEP													
4 Cylinder													
2002	2006	Liberty, Wrangler	2.4L	-	-	-	-	-	87X35	-	-	OE	NR
6 Cylinder													
2007	2011	Wrangler	3.8L	51018	64618	74X18	-	-	84X18	-	-	180	NR
1991	2000	Wrangler, Cherokee, Grand Cherokee, Comanche	4.0L-242	51049	64649	74X49	-	-	84X49	-	-	180/135	8
1975	1991	All	3.8L-232, 4.2L-258	51047	64647	74X47	-	-	84X47	-	-	180/90	9
1987	1990	All	4.0L-242	51048	64648	74X48	-	-	84X48	-	-	180	12
1984	1986	Cherokee, Comanche, Wagoneer	2.8L-173	51000	64600	74X00	-	-	84X00	-	-	180	16
8 Cylinder													
2005	2005	Grand Cherokee w/MDS (OE Replacement Wires)	5.7L HEMI	-	-	72X34	-	-	-	-	-	OE	NR
2005	2005	Grand Cherokee w/MDS (Shorty Conversion Wires)	5.7L HEMI	-	-	72X41	-	-	82X41	-	79X10	OE	NR
1993	1998	Grand Cherokee	5.2L, 5.9L	51076	64676	74X76	-	-	84X76	-	79X82	180	33/37
1970	1991	Cherokee, Comanche, Wagoneer	304, 360, 401	51003	64603	74X03	-	-	84X03	-	79X31	135	18
1971	1980	CJ-5, CJ-6, CJ-7, DJ-5, DJ-6	304	51003	64603	74X03	-	-	84X03	-	79X31	135	18
1968	1971	All	350	51014	64614	74X14	-	-	-	-	-	180/135	11
1966	1968	All	327	51003	64603	74X03	-	-	84X03	-	79X31	135	18
MAZDA													
ROTARY R2													
2004	2011	RX-8	1.3L	-	-	-	-	-	-	-	79X88	90	NR
1971	1985	RX-7	1.1L-12A, 1.3L-13B	-	-	-	-	-	-	-	79X85	135	23/25
4 Cylinder													
1991	2000	MX-5 Miata	1.6L, 1.8 L	-	-	-	-	-	87X26	-	-	OE	NR
1995	2000	B2300, B2500	2.3L, 2.5L	-	-	-	-	-	82X18	-	-	OE	NR
1994	1995	B2300 (Dual Plugs)	2.3L	-	-	-	-	-	84X87	-	-	180	NR
6 Cylinder													
2001	2008	B4000	4.0L SOHC	-	-	-	-	-	82X32	-	-	OE	NR
1997	2000	B4000	4.0L OHV	-	-	-	-	-	82X03	-	-	135	NR
1995	2000	B3000 (Distributorless Ignition)	3.0L	-	-	-	-	-	84X98	-	-	135	NR
1991	1996	B4000, Navajo (w/Distributor)	4.0L	-	-	-	-	-	84X83	-	-	135	NR



Firing America's Finest Rides Since 1923!



CUSTOM WIRE SETS APPLICATION GUIDE

To select wire color, replace X in part # with:

0 = Black

2 = Red

6 = Blue

Check Availability - Not all part numbers currently available in all colors.

Begin Year	End Year	Model	Engine	Street Thunder	High Energy Resistor Core	8mm Spiro Pro	White Ceramic Spiro Pro	Black Ceramic Spiro Pro	Thunder Volt 8.2	Black Ceramic 8.2mm	409 Pro Race	Plug Boot Angle	Coil Wire Length
MINI													
4 Cylinder													
2002	2008	Cooper, Cooper S	1.6L	-	-	72X42	-	-	82X42	-	-	OE	NR
MITSUBISHI													
4 Cylinder													
1995	1999	Eclipse GS, RS (Non-Turbo)	2.0L	-	-	-	-	-	87X35	-	-	OE	NR
1983	1989	Starion	2.6L	-	-	-	-	-	87X30	-	-	180	19/28
1985	1989	Mighty Max Pickup, Ram 50	2.0L, 2.6L	-	-	-	-	-	87X30	-	-	180	19/28
1983	1989	Montero	2.6L	-	-	-	-	-	87X30	-	-	180	19/28
1985	1985	Mirage	1.5L	-	-	-	-	-	87X30	-	-	180	19/28
6 Cylinder													
1997	1999	3000GT	3.0L SOHC	-	-	-	-	-	87X34	-	-	OE	NR
1992	1996	Diamante ES	3.0L SOHC	-	-	-	-	-	87X34	-	-	OE	NR
NISSAN													
4 Cylinder													
1990	1997	D21 Hardbody, Pathfinder	2.4L SOHC	-	-	77X47	-	-	-	-	-	180/135	18/32
1990	1992	Stanza, Axxess (Canada)	2.4L	-	-	77X47	-	-	-	-	-	180/135	18/32
1989	1990	240 SX	2.4L	-	-	77X47	-	-	-	-	-	180/135	18/32
6 Cylinder													
1970	1984	240Z, 260Z, 280Z, 280ZX, 810, Maxima	2.4L, 2.6L, 2.8L	51090	64690	74X90	-	-	84X90	-	-	180/135	18
OLDSMOBILE													
6 Cylinder													
1996	2004	Alero, Silhouette	3.4L (E)	53000	-	72X00	-	-	82X00	-	-	180	NR
1996	2002	Bravada	4.3L (L) Vortec	51035	-	74X35	-	-	84X35	-	-	90/180	12/16
1998	1999	Intrigue	3.8L (K)	53010	-	72X10	-	-	82X10	-	-	180	NR
1996	1999	88 & 98 (Supercharged)	3.8L (1)	-	-	-	-	-	82X13	-	-	180	NR
1995	1999	Achieva, Cutlass	3.1L (M)	53000	-	72X00	-	-	82X00	-	-	180	NR
1994	1994	Achieva	3.1L (M)	53000	-	72X00	-	-	82X00	-	-	180	NR
1991	1994	Bravada	4.3L (WZ)	51032	64632	74X32	-	-	84X32	-	-	90/180	12
1991	1992	88, 98	3.8L (L)	-	-	-	-	-	84X40	-	-	180	NR
1987	1990	88, 98, Toronado	3.8L (C)	-	-	-	-	-	84X40	-	-	180	NR
1985	1987	Ciera	2.8L (X)	51000	64600	74X00	-	-	84X00	-	-	180	16
1985	1986	Ciera, Firenza (w/Hi-Output)	2.8L (W)	-	-	74X24	-	-	84X24	-	79X24	180	18
1985	1986	Ciera, 88, 98, Supreme	3.0L	51000	64600	74X00	-	-	84X00	-	-	180	16
1985	1985	Ciera, 88, 98, Supreme	3.8L	51000	64600	74X00	-	-	84X00	-	-	180	16
1984	1984	Ciera, Cutlass, Omega, 88	2.8L, 3.0L, 3.8L	51000	64600	74X00	-	-	84X00	-	-	180	16
1984	1984	Toronado	4.1L	51000	64600	74X00	-	-	84X00	-	-	180	16
1983	1983	Ciera, Omega	2.8L, 3.0L	51000	64600	74X00	-	-	84X00	-	-	180	16
1983	1983	Cutlass, 88, 98, Toronado	3.8L, 4.1L	51000	64600	74X00	-	-	84X00	-	-	180	16
1982	1982	Ciera, Cutlass, 88, 98, Toronado	2.8L, 3.0L, 3.8L, 4.1L	51000	64600	74X00	-	-	84X00	-	-	180	16
1981	1981	Cutlass, 88, 98, Omega, Toronado	2.8L, 3.8L, 4.1L	51000	64600	74X00	-	-	84X00	-	-	180	16
1980	1980	Ciera, Cutlass, 88, 98, Starfire	2.8L, 3.8L	51000	64600	74X00	-	-	84X00	-	-	180	16
1977	1979	All Models	231, 3.8L	51000	64600	74X00	-	-	84X00	-	-	180	16
1975	1976	Starfire	231, 3.8L	51000	64600	74X00	-	-	84X00	-	-	180	16
8 Cylinder													
1991	1992	Custom Cruiser	5.0L (E), 5.7L (7)	51011	64611	74X11	-	-	84X11	-	-	90/180	10
1988	1990	Custom Cruiser	5.0L (Y)	51004	64604	74X04	-	-	84X04	-	79X32	135	12
1988	1988	Cutlass	5.0L (Y)	51004	64604	74X04	-	-	84X04	-	79X32	135	12
1987	1987	Cutlass	5.0L (H, 9, Y)	51004	64604	74X04	-	-	84X04	-	79X32	135	12
1986	1986	Custom Cruiser, Cutlass, Supreme	305, 307	51004	64604	74X04	-	-	84X04	-	79X32	135	12
1986	1986	Cutlass (Canada)	305	51007	64607	74X07	-	-	84X07	-	-	90/135	NR
1980	1985	Cutlass, Supreme, 88, 98	305, 5.0L (H)	51007	64607	74X07	-	-	84X07	-	-	90/135	NR
1980	1985	Ciera, Cutlass, Toronado, 88, 98	307, 5.0L (Y, 9)	51004	64604	74X04	-	-	84X04	-	79X32	135	12
1981	1983	Ciera, Cutlass, 88, 98, Toronado	260, 4.3L	51004	64604	74X04	-	-	84X04	-	79X32	135	12
1982	1982	Cutlass, Delta 88, 98	267, 4.4L	51007	64607	74X07	-	-	84X07	-	-	90/135	NR
1980	1980	Cutlass, 88, 98, Starfire, Toronado	260, 350	51004	64604	74X04	-	-	84X04	-	79X32	135	12
1979	1979	Delta 88	301, 4.9L	51016	64616	74X16	-	-	84X16	-	-	180/135	NR
1979	1979	Cutlass	305, 350 (L)	51007	64607	74X07	-	-	84X07	-	-	90/135	NR
1977	1979	Cutlass, 88, 98, Toronado	260, 350 (R), 403	51004	64604	74X04	-	-	84X04	-	79X32	135	12
1977	1979	Omega	305, 350 (L)	51002	64602	74X02	-	-	84X02	-	79X32	90	10
1978	1978	Cutlass	305	51007	64607	74X07	-	-	84X07	-	-	90/135	NR
1977	1977	Cutlass, Omega, 88, 98	305, 350 (L)	51002	64602	74X02	-	75028-B	84X02	-	79X28	90	10
1974	1976	Cutlass, Omega, 88, 98 (w/HEI)	260, 350, 450	51004	64604	74X04	-	-	84X04	-	79X32	135	12
1974	1976	Cutlass, 88, 98, Toronado (w/HEI)	400, 455	51004	64604	74X04	-	-	84X04	-	79X32	135	12
1974	1974	All Models	350, 455	51062	64662	74X62	-	-	84X62	-	-	135	14
1973	1973	All Models	350, 455	51003	64603	74X03	-	-	84X03	-	79X31	135	18
1955	1972	All Models	ALL	51052	64652	74X52	-	-	84X52	-	79X65	180	14/15
PONTIAC													
6 Cylinder													
2007	2010	G6	3.5L (K,N)	53048	-	-	-	-	82X48	-	-	OE	NR
2006	2009	G6	3.9L (1)	53048	-	-	-	-	82X48	-	-	OE	NR
2006	2009	Montana	3.9L (1) (W)	53048	-	-	-	-	82X48	-	-	OE	NR
2006	2009	Torrent	3.4L (F)	53047	-	-	-	-	82X47	-	-	OE	NR
2006	2008	Grand Prix, GT	3.8L (2)	53010	-	72X10	-	-	82X10	-	-	180	NR
2006	2008	Grand Prix GTP (Supercharged)	3.8L (4)	53006	-	72X06	-	-	82X06	-	-	180	NR
2005	2006	G6	3.5L	53047	-	-	-	-	82X47	-	-	OE	NR
2005	2006	Montana	3.5L (L) (8)	53047	-	-	-	-	82X47	-	-	OE	NR



Firing America's Finest Rides Since 1923!



CUSTOM WIRE SETS APPLICATION GUIDE

To select wire color, replace X in part # with:

0 = Black 2 = Red 6 = Blue

Check Availability - Not all part numbers currently available in all colors.

Begin Year	End Year	Model	Engine	Street Thunder	High Energy Resistor Core	8mm Spiro Pro	White Ceramic Spiro Pro	Black Ceramic Spiro Pro	Thunder Volt 8.2	Black Ceramic 8.2mm	409 Pro Race	Plug Boot Angle	Coil Wire Length
PONTIAC (Continued)													
2004	2005	Azteck, Montana	3.4L (E)	53000	-	72X00	-	-	82X00	-	-	180	NR
1996	2005	Grand Am, Transport	3.4L (E)	53000	-	72X00	-	-	82X00	-	-	180	NR
1996	2005	Grand Prix, Grand Prix GT	3.8L (K)	53010	-	72X10	-	-	82X10	-	-	180	NR
1997	2004	Grand Prix GTP (Supercharged)	3.8L (1)	53006	-	72X06	-	-	-	-	-	180	NR
1995	2004	Grand Am, Grand Prix SE	3.1L (M)	53000	-	72X00	-	-	82X00	-	-	180	NR
1996	2003	Bonneville SSEi (Supercharged)	3.8L (1)	-	-	-	-	-	82X13	-	-	180	NR
2000	2002	Firebird	3.8L (K)	-	-	-	-	-	-	-	-	180	NR
1995	1999	Firebird	3.8L (K)	-	-	-	-	-	84X43	-	-	90	NR
1994	1994	Grand Am	3.1L (M)	53000	-	72X00	-	-	82X00	-	-	180	NR
1992	1992	Bonneville	3.8L (L)	-	-	-	-	-	84X40	-	-	180	NR
1990	1992	Firebird	3.1L (T)	51000	-	74X00	-	-	84X00	-	-	180	16
1988	1991	Bonneville	3.8L (C)	-	-	-	-	-	84X40	-	-	180	NR
1989	1989	Firebird	2.8L (S)	-	-	74X24	-	-	84X24	-	79X24	180	18
1985	1988	Fiero, Fiero GT	2.8L (9)	-	-	74X24	-	-	84X24	-	79X24	180	18
1987	1987	Firebird	2.8L (S)	51000	64600	74X00	-	-	84X00	-	-	180	16
1987	1987	Grand Prix	3.8L (A)	51000	64600	74X00	-	-	84X00	-	-	180	16
1986	1986	Bonneville, Grand Prix	3.8L (A)	51000	64600	74X00	-	-	84X00	-	-	180	16
1985	1986	Firebird, 6000	2.8L (S,X)	51000	64600	74X00	-	-	84X00	-	-	180	16
1985	1986	6000 (w/Hi-Output)	2.8L (W)	-	-	74X24	-	-	84X24	-	79X24	180	18
8 Cylinder													
2009	2009	G8 GXP	6.2L (W)	51044	-	74X44	-	75044-B	84X44	85044-B	79X03	180	NR
2009	2009	G8 GT	6.0L	51044	-	74X44	-	75044-B	84X44	85044-B	79X03	180	NR
2005	2008	Grand Prix GXP	5.3L LS4 (C)	53044	-	72X44	-	-	82X44	-	79X06	OE	NR
2005	2006	GTO	6.0L (H) LS-2	53044	-	72X44	-	-	82X44	-	79X06	OE	NR
2004	2004	GTO	5.7L (S) LS-1	51044	-	74X44	-	75044-B	84X44	85044-B	79X03	180	NR
1998	2002	Firebird, Firehawk, Formula	5.7L (P) LS-1	51044	-	74X44	-	75044-B	84X44	85044-B	79X03	180	NR
1996	1997	Firebird, Firehawk	5.7L (P) LT1	51039	-	74X39	-	-	84X39	-	-	90	10/11
1993	1995	Firebird	5.7L (P) LT1	51026	-	74X26	-	-	84X26	-	-	90	12
1988	1992	Firebird	5.0L (E,F), 5.7L (8)	51011	64611	74X11	-	-	84X11	-	-	90/180	10
1987	1989	Safari	5.0L (Y)	51004	64604	74X04	-	-	84X04	-	79X32	135	12
1987	1987	Firebird	5.0L (F, H)	51011	64611	74X11	-	-	84X11	-	-	90/180	10
1987	1987	Firebird	5.7L (8)	51009	64609	74X09	-	-	84X09	-	-	90/135	NR
1986	1986	Parisienne	5.0L (Y)	51004	64604	74X04	-	-	84X04	-	79X32	135	12
1986	1986	Firebird, Parisienne	5.0L (G, H)	51007	64607	74X07	-	-	84X07	-	-	90/135	NR
1986	1986	Parisienne	5.0L	51007	64607	74X07	-	-	84X07	-	-	90/135	NR
1984	1986	Bonneville, Grand Prix, Parisienne	5.0L	51007	64607	74X07	-	-	84X07	-	-	90/135	NR
1984	1984	Firebird	5.0L	51007	64607	74X07	-	-	84X07	-	-	90/135	NR
1982	1983	Bonneville, Firebird, Grand Prix	5.0L	51007	64607	74X07	-	-	84X07	-	-	90/135	NR
1980	1981	Grand Am, Grand Prix, Lemans	267, 305, 350	51007	64607	74X07	-	-	84X07	-	-	90/135	NR
1978	1981	All Models	265, 301, 400	51016	64616	74X16	-	-	84X16	-	-	180/135	NR
1979	1980	Firebird (Except Calif.)	305, 350	51002	64602	74X02	-	75028-B	84X02	-	79X28	90	10
1979	1979	Grand Prix, Lemans	305, 350	51007	64607	74X07	-	-	84X07	-	-	90/135	NR
1978	1979	Bonneville	350 (R, X)	51004	64604	74X04	-	-	84X04	-	79X32	135	12
1978	1979	Bonneville, Firebird	403	51004	64604	74X04	-	-	84X04	-	79X32	135	12
1978	1978	Firebird, Grand Prix	305, 350	51002	64602	74X02	-	75028-B	84X02	-	79X28	90	10
1978	1978	Bonneville	301, 4.9L	51002	64602	74X02	-	75028-B	84X02	-	79X28	90	10
1977	1977	Bonneville, Firebird, Grand Prix, Lemans	ALL	51016	64616	74X16	-	-	84X16	-	-	180/135	NR
1977	1977	Phoenix, Ventura	305, 350 (L)	51002	64602	74X02	-	75028-B	84X02	-	79X28	90	10
1975	1976	All Models (w/HEI)	260	51004	64604	74X04	-	-	84X04	-	79X32	135	12
1974	1976	All Models (w/HEI)	350, 400, 455	51016	64616	74X16	-	-	84X16	-	79X32	180/135	NR
1973	1974	All Models (w/o HEI)	350, 400, 455	51062	64662	74X62	-	-	84X62	-	79X31	135	14
1970	1972	All Models	350, 400, 455	51003	64603	74X03	-	-	84X03	-	79X31	135	18
1968	1969	All Models	350, 400, 428	51051	64651	74X51	-	-	84X51	-	79X79	180	14/14
1966	1967	All Models	326, 400, 428	51003	64603	74X03	-	-	84X03	-	79X31	135	18
1963	1965	All Models	326, 389, 421	51051	64651	74X51	-	-	84X51	-	79X79	180	14/14
1959	1964	All Models (Except 215)	ALL	51051	64651	74X51	-	-	84X51	-	79X79	180	14/14
1961	1962	All Models	215	51071	64671	74X71	-	-	84X71	-	-	180	14/25

NISSAN

8 Cylinder													
2009	2009	9-7X Aero	5.3L (M), 6.0L (H)	51044	-	74X44	-	75044-B	84X44	85044-B	79X03	180	NR
2005	2008	9-7X Aero	5.3L (M), 6.0L (H)	53044	-	72X44	-	-	82X44	-	79X06	OE	NR

SATURN

6 Cylinder													
2007	2009	Aura, Vue	3.5L (N)	53048	-	-	-	-	82X48	-	-	OE	NR
2006	2007	Relay	3.9L (1) (N) (W)	53048	-	-	-	-	82X48	-	-	OE	NR
2005	2006	Relay	3.5L	53047	-	-	-	-	82X47	-	-	OE	NR
2005	2006	Relay	3.5L (L) (8)	53047	-	-	-	-	82X47	-	-	OE	NR

TOYOTA

4 Cylinder													
1983	1992	Pickup, 4-Runner (22R, 22REC, 22RET)	2.2L, 2.4L	-	-	-	-	-	87X50	-	-	180	24

VOLKSWAGEN

H4 Air Cooled													
1953	1978	(Type 1-2) 1200, 1300, 1500, 1600cc (Air Cooled Engines)	Socket-1.2, 1.3, 1.5, 1.6L	51091	64691	74X91 **	-	-	84X91	-	-	OE	11
6 Cylinder													
1994	1999	Jetta (SOHC)	2.8L (AAA) VR6	-	-	77X84	-	-	-	-	-	180	26
1995	1999	Golf GTI (SOHC)	2.8L (AAA) VR6	-	-	77X84	-	-	-	-	-	180	26
1993	1997	Passat (SOHC)	2.8L (AAA) VR6	-	-	77X84	-	-	-	-	-	180	26
1992	1995	Corrado (SOHC)	2.8L (AAA) VR6	-	-	77X84	-	-	-	-	-	180	26

** 8mm Spiro Pro available in 6 additional colors - 1= Purple, 3= Orange, 4= Yellow, 5= Lime, 7= Pink, 54891 = Gray



Firing America's Finest Rides Since 1923!





*Firing America's Finest
Rides Since 1923!*

CABLE PRODUCTS



WARNING This product can expose you to chemicals such as lead which is known to the State of California to cause cancer and birth defects or other reproductive harm. For more information go to: www.P65Warnings.ca.gov/product



Follow Us

909-599-5955

10955 Mill Creek Road • Lenexa, KS 66219

www.pertronixbrands.com